

Use of advanced sensitivity approach to novel optical compensation methods

Mark C. Sanson & Keith Hanford
Corning Incorporated, 60 O'Connor Rd., Fairport, NY, USA 14450

ABSTRACT

Understanding the sensitivity of optical systems thoroughly can lead to improved tolerancing and compensation. An examination into a complex sensitivity analysis is shown. This analysis is used to improve the overall tolerancing and compensation of an optical system. We have developed a tool to facilitate this method of sensitivity analysis. An example of a novel compensation method is presented.

Keywords: Optical design, sensitivity, compensation

1. INTRODUCTION

The ability to understand an optical system's sensitivities is important to building the system with the best performance and cost. Commercial optical design programs all have the ability to run basic sensitivities of an optical system. With more complex optical systems, there is significant effort placed into finding a build strategy for the system. Many post assembly adjustments are implemented to achieve acceptable performance without tightening component specification to a cost prohibitive level.¹ Because of these adjustments, basic sensitivities of an optical system lose much of their value. In this paper we examine what Corning refers to as advanced sensitivities. We examine how this differs from an ordinary sensitivity routine.

We discuss a tool that allows an optical designer to easily perform these advanced sensitivities. Using this tool we show a method which searches for ideal compensators in an optical system. Finally, we provide an example demonstrating the implementation of a novel compensation method.

2. ADVANCED SENSITIVITY

A sensitivity table consists of the change in a performance metric for component manufacturing attributes of an optical system. A sensitivity table is generated by individually perturbing each component and evaluating the change to a certain metric. For example, one could examine how the focus location changes with a given thickness change for each element. Commercial optical design programs all support this type of analysis. Many of the programs also allow some type of compensation to occur before the evaluation is done. This feature is important since most optical systems allow a refocusing of some type to be done. Without the ability to refocus, defocus would likely affect the wavefront error more than other aberrations. If the user wishes to understand the loss in RMS wavefront error due to a change in the optical system, the system is refocused first.

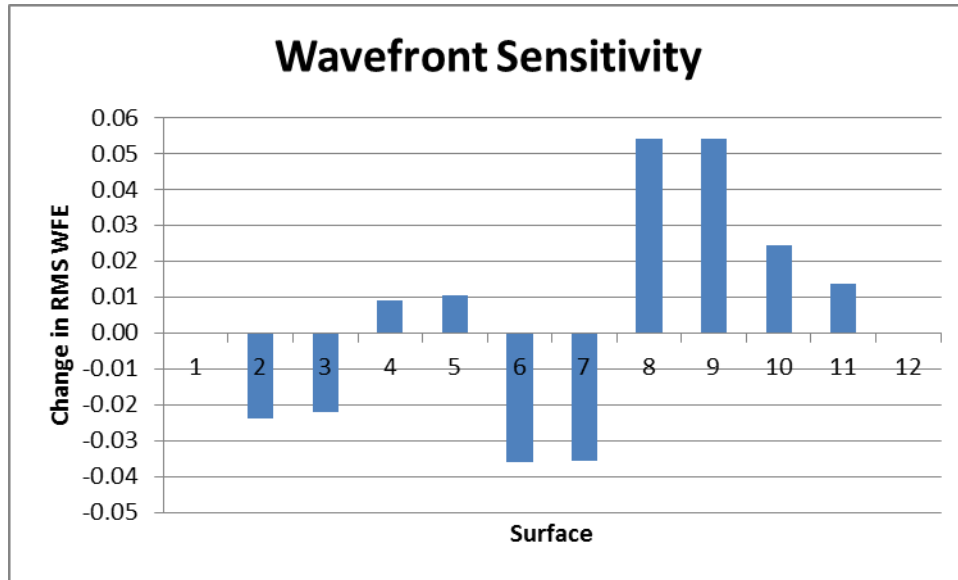

Figure 1. Typical Wavefront Sensitivity Table showing change in RMS WFE for each thickness in an optical system

As optical systems increase in complexity, more advanced tools are needed to build them. Sensitivity analysis needs to adapt with this change to remain useful. This paper discusses some of the changes Corning has built into their in-house design tools which allow for more, and more useful, information to be gathered from sensitivity analysis. This advanced sensitivity is designed to give the optical designers insight into how to best tolerance an optical system.

Features of advanced sensitivity include many aspects not currently available in the commercial optical design programs. These capabilities include handling of any optical system as input, implementation of any type of perturbation, evaluation for standard or user defined parameters, multiple evaluations for each perturbation, uncompensated and compensated evaluation, and plus and minus perturbations. Because analysis of non-standard perturbations may be required in an optical system, it is important to have the flexibility to create any type of change the optical design program can perform in a sensitivity program. Since there are often many different specifications an optical system must meet, it is beneficial if these evaluations can be performed at the same time for each perturbation on the optical system. The program allows the user to easily examine both directions of each perturbation. There are times in an optical system when the change in an evaluator is not of the same magnitude if the perturbation direction is changed. This could be because of a non-linear region of the sensitivity or because of a constraint in the compensation.

The ability to perform an uncompensated evaluation versus a compensated evaluation is critical. By uncompensated evaluation, we refer to evaluating the optical system after each perturbation with no other changes to recover the performance except for a possibility of refocus. Precision optical systems rarely meet tight performance specifications without some manner of compensation.² This compensation is an attempt to recover the system's designed performance while allowing tolerances to be manufacturable and cost effective. This could be changing a space between elements or laterally moving an element. When comparing uncompensated and compensated sensitivities we find that the relative sensitivities of different parts of the optical system often change. This is seen in the figure below where the compensation employed has significantly reduced the sensitivity of elements #2 & 3. The tolerances of an optical system may be based upon these compensated sensitivities and not the uncompensated.

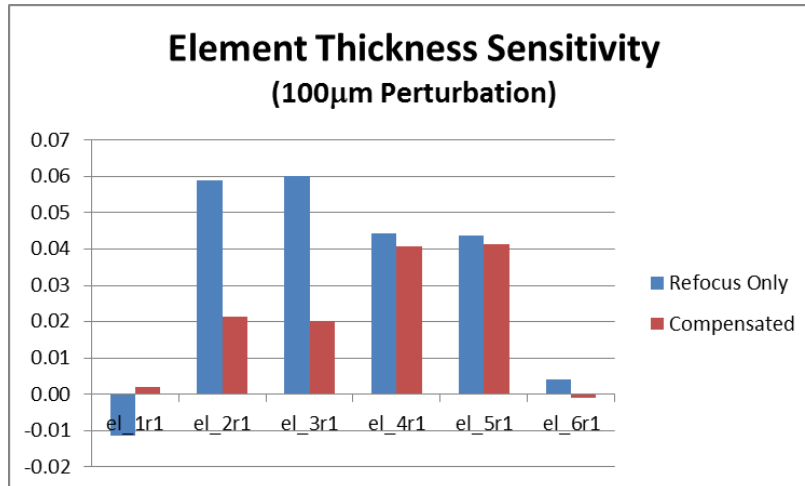

Figure 2. Change in sensitivities with compensation

3. ADVANCED SENSITIVITY TOOL

In 2006, we presented a tool which allowed basic sensitivities to be run through a Microsoft Excel interface.³ The Excel workbook uses VBA and COM to interface with the optical design program CodeV. Although this program was easy to use, it was very restrictive in its functionality. Corning has noted the benefits of using COM and interfacing with the optical design program with Excel or MatLab.^{4,5} An advanced sensitivity tool now exists, which aids the optical designer's ability to understand the sensitivity of the optical design. This is not restricted by the limitations of the commercial optical design program. With CodeV's⁶ macro language, there are few limitations on analysis. We have migrated legacy sensitivity macros into Excel and continually advance the capabilities. The current advanced sensitivity program allows implementation of any type of perturbation and combinations of perturbations. Any type of evaluation or suite of evaluations can be examined. Inverse sensitivities are also able to be examined.

There are three parts to the tool created. There is a lens listing worksheet, symmetrical worksheets, and asymmetrical worksheets. The lens listing worksheet primarily is used for archiving the lens deck examined. The figure below shows what the worksheet looks like for a sample double Gauss objective. When the file is selected, the program opens up a session of CodeV which then loads the lens deck. The prescription and the lens layout information are entered onto this worksheet.

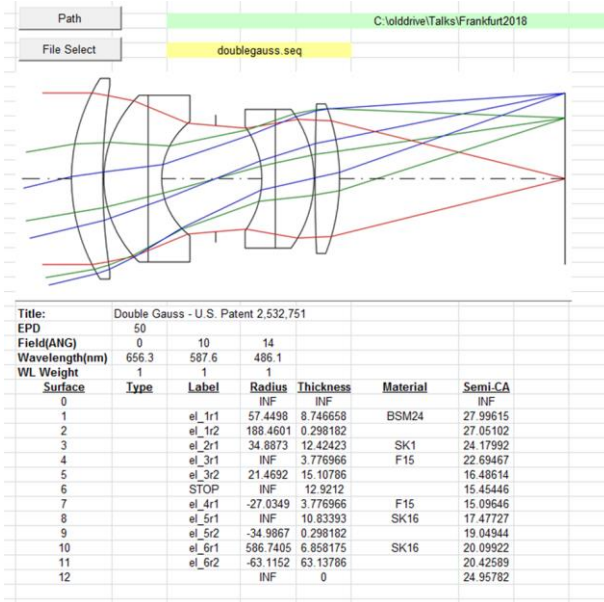

Figure 3. Lens layout and surface listing

The symmetrical and asymmetrical worksheets function the same except for the forms which pop up to aid the user in selecting default perturbations and evaluations. There is one worksheet for the input parameters and one worksheet for displaying the results of a sensitivity run. Several features of the sensitivity input worksheet are noted in figure 4. There is a location for selecting the lens file, buttons which will bring up forms to help populate the perturbation and evaluation lists, and options for how to compensate the lens deck.

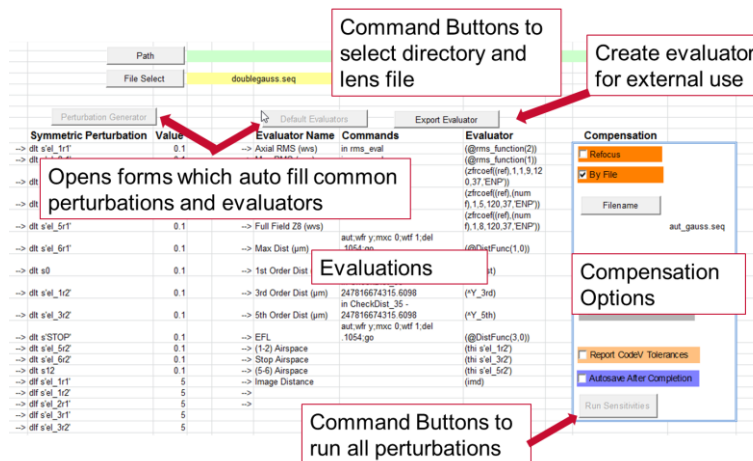

Figure 4. Sample worksheet for setting up the sensitivity run

The results worksheets display a table of sensitivity data. By using Excel as the client program, the charting features are readily available to the user to aid in visualizing the data. The worksheet also allows inverse sensitivity to be examined for any selected evaluator.

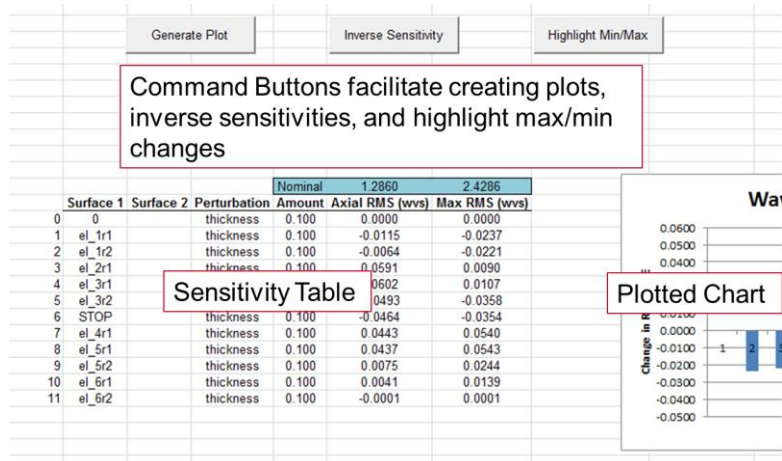

Figure 5. Example of sensitivity results worksheet

4. IDEAL COMPENSATOR SEARCH

Building a precision optical system often involves compensation to the system after the initial build is completed. This post construction adjustment allows for the fabrication tolerances to be relaxed. Often the compensators chosen will impact more than one aberration. This lack of orthogonally of the compensators results in iterations of correcting the wavefront errors. The ideal compensator is one which will correct for a specific aberration without adversely affecting other aberrations. This orthogonal compensator will make the adjustment of the lens easier and often reduces the time required to complete the lens. One typical adjustment is a lateral movement of an element. A designer typically accomplishes this by adjusting screws which would push on a cell in which the element is located.¹

When evaluating the sensitivity of the decenter of the individual optical elements in a system, we often find that there is not an ideal compensator. If an optical system requires adjusting elements for axial coma and balancing astigmatism, we rarely will find two elements which can be decentered to correct these aberrations without adversely affecting the other. It is not uncommon to iterate between two lateral adjusters to fix the wavefront in an optical system. Figure 6 displays the centration sensitivities of the elements of an optical system. There are some options available for correcting the asymmetric astigmatism in the system, but there are no elements where coma can be adjusted without also affecting the astigmatism.

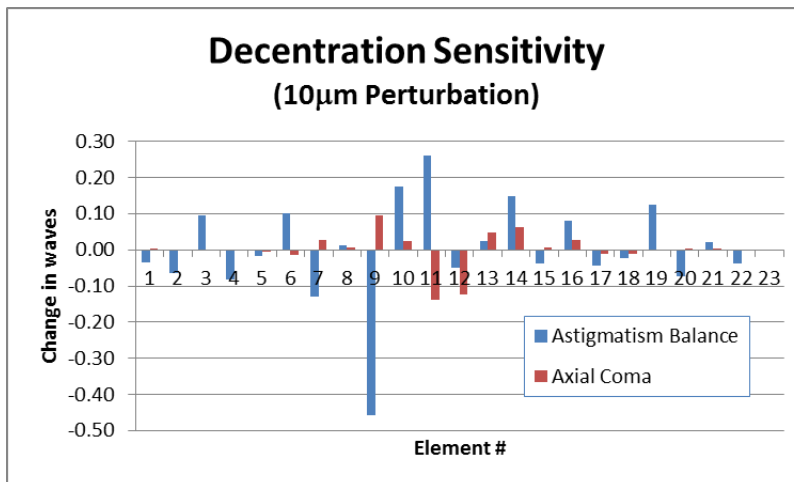

Figure 6. Centration sensitivities of an optical system

With the use of the advanced sensitivity tool described above, we will demonstrate a method of finding an ideal compensator that is not solely decentered, but tilted about a virtual point on the optical axis. A sensitivity table and chart were generated for each element with the axial pivot location changing location on the optical axis. Figure 7 shows this sensitivity for two elements in the optical system.

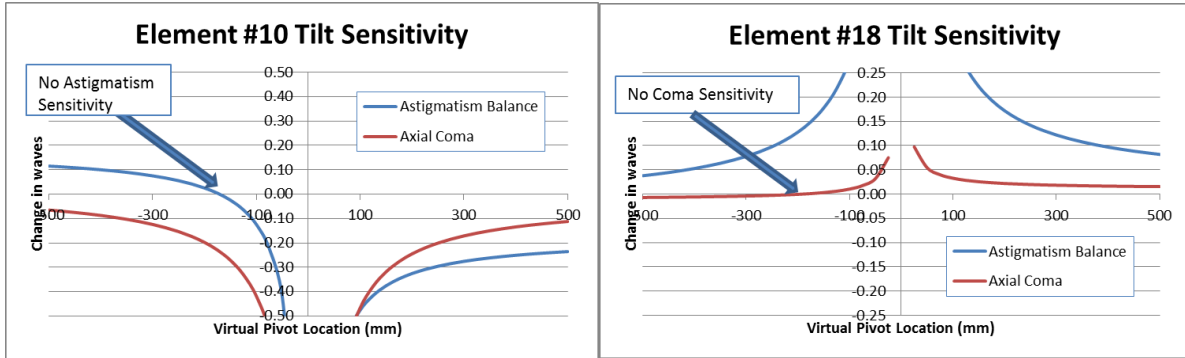

Figure 7. Tilt sensitivities of two elements with virtual pivot points along the optical axis

Based upon the sensitivity, element #10 is an ideal compensator for axial coma. By adjusting the lens about a virtual point 175mm on one side of the lens there is no astigmatism introduced. It is also shown that the sensitivity to coma is larger here than if the lens was decentered. This would reduce the necessary motion needed for this compensator. In examining the chart for element #18 on the right in figure 7, we see that there is a point to pivot the lens which will affect the astigmatism balance without changing the axial coma. Like element 10, this element will require less motion for compensation than it would if a pure decenteration was implemented. With these two compensators we are able to independently adjust the optical system's wavefront asymmetries without having to iterate between adjustments of the two elements. Figure 8 displays the uncompensated and compensated wavefront errors. By employing the two compensators above, the wavefront errors are recovered with no iteration necessary.

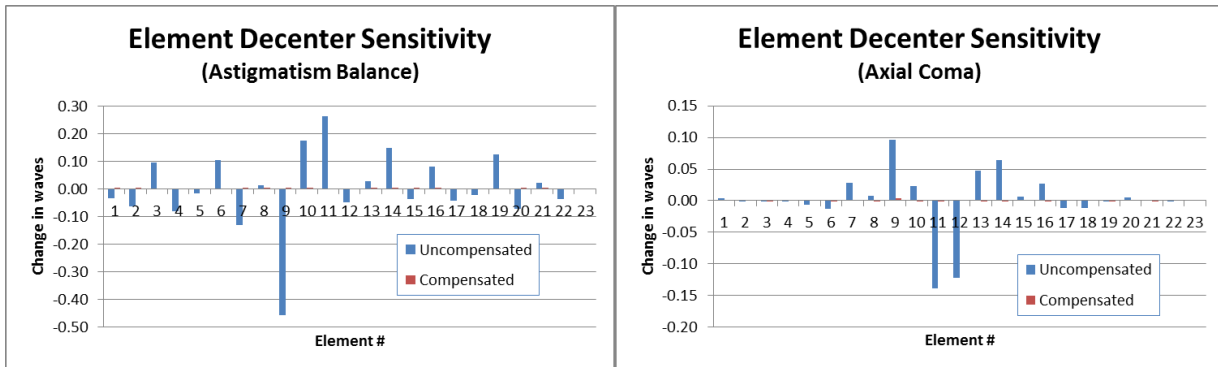

Figure 8. Tilt sensitivities of two elements with virtual pivot points along the optical axis

5. TIRE SWING ADJUSTMENT

The tip-tilt compensation adjustment moves similar to a tire swing where the annulus (or tire) represents the element (see figure 9).⁷

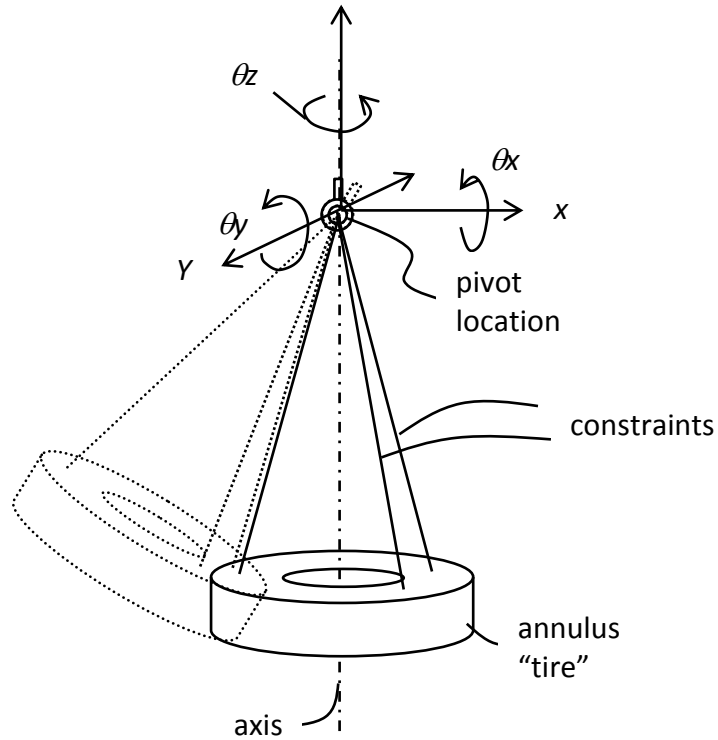

Figure 9. "Tire swing" Tip-tilt compensator

This adjustment has a virtual pivot point on the optical axis some distance from the optical element. The tire swing has three rotations and displacements. The tip-tilt adjustment uses two rotations and limits the third rotation about the optical axis. For optical performance reasons, the two desired rotations are small, therefore, the metal holding the optical element can use flexures to provide the required motion about the virtual pivot point between the fixed outer portion of the metal and the moveable inner portion of the metal (see figure 10).

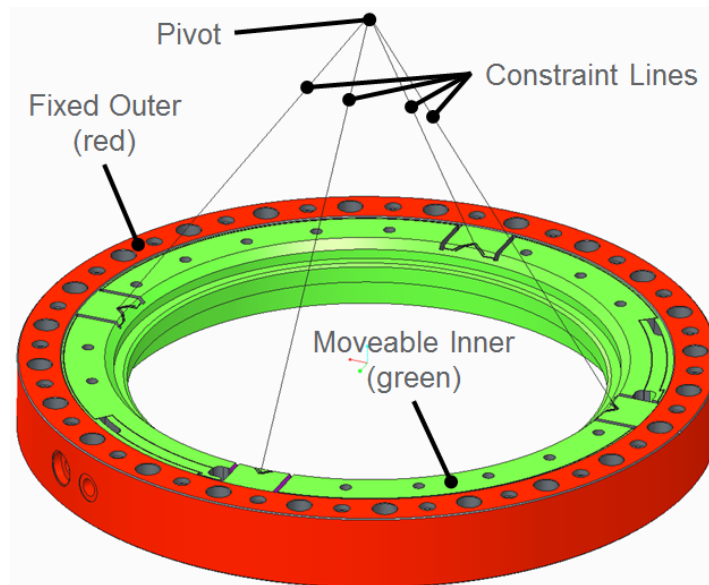

Figure 10. Mechanical implementation of compensator

The wavefront errors are generally represented by Zernike polynomials which have radial (r) and azimuthal (Θ) terms. The azimuthal terms are in terms of cosines and sines. Therefore it is desired to have orthogonal control of the tip-tilt motions. This control is provided by connections between the inner and outer portions of the metal. These connections can use manual adjust devices or remotely controlled motion devices.

6. CONCLUSION

As optical designs continue to advance in complexity and require tighter performance requirements, optical designers need advanced tools to aid in determining the build methodology. With a tool to perform advanced sensitivities an optical designer can gain further insight into what aspects of a lens are truly more sensitive and what compensation methods could aid in the build of the optical system. With the advanced sensitivity tool presented we have noted the ease of finding new methods of compensation. We have presented a new, novel method of compensation of non-rotationally symmetric aberrations. This tire swing method allows for orthogonal correction of aberrations.

REFERENCES

- [1] Paul R. Yoder, Jr. "Mounting Optics in Optical Instruments." SPIE Press, Bellingham, WA (2008).
- [2] C. T. Tienvieri, and T. Rich, "Optical design compensation from engineering to production manufacturing." Proc. SPIE 6342, 63422S-63422S-5 (2006).
- [3] M. C. Sanson, "Use of an application programming interface (API) to allow non-optical designers to perform specific optical evaluations." Proc. SPIE 6342, 634205-634205-6 (2006).
- [4] Microsoft Excel® is a registered trademark of Microsoft Corporation, WA.
- [5] M. C. Sanson, "Understanding product cost vs. performance through an in-depth system Monte Carlo analysis." Proc. SPIE 10377, 7 (2017).

- [6] O. S. G. CODE V® is a registered trademark of Synopsys, Pasadena, CA.
- [7] U.S. Patent #7612956 Optical Mount Pivotal About A Single Point, Douglas L. Blanding, John H. Bruning, Jack W. Frankovich, Keith E. Hanford, Kevin J. Magierski & Mark C. Sanson; Corning Incorporated; November 3, 2009