

visual installation instructions UniCam[®] High-Performance Tool Kit

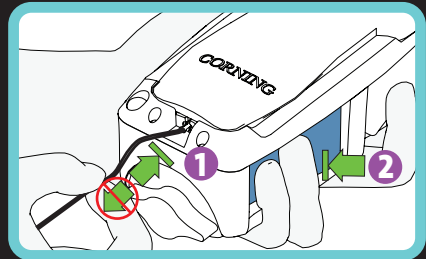
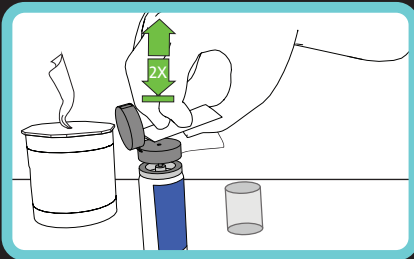
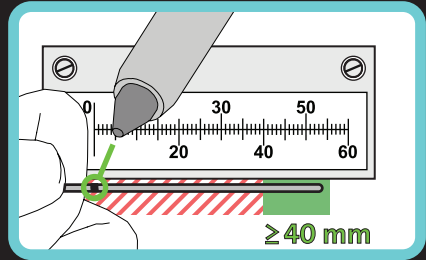
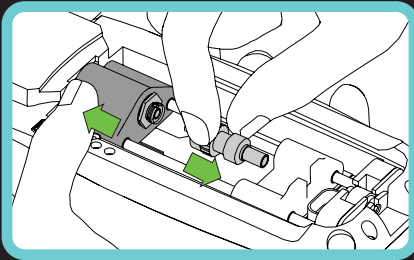

English

Visual Installation Instructions for the UniCam[®]
High-Performance Tool Kit with FBC-007 Cleaver

Deutsch

Visuelle Montageanweisung für das UniCam[®] High-Perfor-
mance Werkzeug mit FBC-007 Trenngerät Inhaltsverzeichnis

Français

Instructions visuelles pour la trousse de montage UniCam[®]
haute performance avec cleaver FBC-007

Español

Guía de instalación visual de la herramienta de Alto
desempeño UniCam[®] con Cortadora FBC-007

CORNING

LANscape[®]
Solutions

Safety Precautions

Optical Fiber Precautions

	<p>WARNING: Cleaved or broken glass fibers are very sharp and can pierce the skin or damage the eyes easily. Do not let pieces of fiber stick to your clothing or drop in the work area where they can cause injury later. Use tweezers to pick up pieces of fiber and place them on a loop of tape kept for that purpose alone. Good housekeeping is very important.</p>
--	--

Chemical Precautions

	<p>CAUTION: Fiber Optic Cleaning Fluid can cause irritation to eyes on contact. In case of eye contact, immediately flush eyes with water for at least 15 minutes. Inhaling fumes may be harmful. Use with adequate ventilation. In case of ingestion, consult a physician.</p>
--	--

Laser Handling Precautions

	<p>WARNING: Never look directly into the end of a fiber that may be carrying laser light. Laser light can be invisible and can damage your eyes. Viewing it directly does not cause pain. The iris of the eye will not close involuntarily as when viewing a bright light. Consequently, serious damage to the retina of the eye is possible. Should accidental eye exposure to laser light be suspected, arrange for an eye examination immediately.</p>
--	--

Safety Glasses Precautions

	<p>CAUTION: Recommend the use of safety glasses (spectacles) conforming to ANSI Z87, for eye protection from accidental injury when handling chemicals, cables, or working with fiber. Pieces of glass fiber are very sharp and have the potential to damage the eye.</p>
--	--

Laser Safety

	<p>The High-Performance UniCam® Installation Tool conforms to the requirements contained in IEC 60825-1:1993 plus Amendments 1:1997 and 2:2001. $P_{max} < 1.0 \text{ mW}$, $\lambda = 635 \text{ nm}$ CLASS 1 M LASER-LIGHT DO NOT VIEW DIRECTLY WITH OPTICAL INSTRUMENTS (MAGNIFIERS). CLASS 1M LASER PRODUCT</p> <p>CAUTION: Use of controls or adjustments or performance of procedures other than those specified herein may result in hazardous radiation exposure.</p>
--	---

Cable Handling Precautions

<p>NOTE: Fiber optic cable is sensitive to excessive pulling, bending, and crushing forces. Consult the cable specification sheet for the cable you are installing. Do not bend the cable more sharply than the minimum recommended bend radius. Do not apply more pulling force to the cable than specified. Do not crush the cable or allow it to kink. Doing so may cause damage that can alter the transmission characteristics of the cable; the cable may have to be replaced.</p>

For additional safety information, please visit www.corning.com/opcomm/safety

Precauciones de Seguridad

Precauciones con el manejo de fibra óptica

	<p>ADVERTENCIA: Las fibras de vidrio son objetos cortantes y pueden perforar la piel o causar daños en los ojos fácilmente. Evite que los sobrantes de fibra se adhieran a su ropa o caigan en el área de trabajo. Utilice pinzas para coger los sobrantes de fibra y colóquenlos sobre un segmento de cinta pegante designada para los desechos de fibra óptica. Mantener el área de trabajo limpia es de vital importancia.</p>
---	--

Precauciones Químicas

	<p>PRECAUCIÓN: El líquido limpiador de fibra óptica puede causar irritación en los ojos. En caso de contacto visual, limpie inmediatamente los ojos con agua por lo menos por 15 minutos. La inhalación puede ser perjudicial. Utilice ventilación adecuada. En caso de la ingestión, consulte a un médico.</p>
---	--

Precauciones en el Manejo Láser

	<p>ADVERTENCIA: Nunca mire directamente el final de una fibra que pueda estar conectado a un dispositivo láser. La luz láser puede ser invisible y causar daños en los ojos. Al mirar la luz, esta no causará dolor. La Iris del ojo no se cerrará involuntariamente como lo hace al ver una luz brillante. Por lo tanto, es posible el daño grave a la retina del ojo. Si sospecha de exposición consulte a un médico inmediatamente, es posible que se deba realizar un examen visual.</p>
---	---

Precauciones de las gafas de seguridad

	<p>PRECAUCIÓN: Se recomienda el uso de las gafas de seguridad conforme a ANSI Z87, para la protección de los ojos contra lesiones accidentales al utilizar productos químicos, cables de fibra óptica, y/o en el manejo de fibra óptica. Las fibras ópticas de vidrio son objetos cortantes y punzantes que le pueden causar daños a los ojos.</p>
---	---

Seguridad del Láser

	<p>La herramienta de alto rendimiento UniCam® se ajusta a los requisitos contenidos en IEC 60825-1: 1993 y las de las enmiendas 1:1997 y 2:2001. El poder máximo < de 1.0 mW, $\lambda=635\text{nm}$</p> <p style="text-align: center;">LUZ LASER NO VEA LA LUZ DIRECTAMENTE CON LOS INSTRUMENTOS ÓPTICOS (LUPAS). LASER CLASE 1M</p> <p>PRECAUCIÓN: El uso de controles y/o ajustes en el funcionamiento en los procedimientos con excepción de los especificados en este documento, puede dar lugar a la exposición de radiación peligrosa.</p>
---	--

Precauciones al manejo de cables de fibra óptica

<p>NOTA: El cable de fibra óptica es sensible a fuerzas excesivas de tensión, doblez y aplastamiento. Consulte la hoja de especificación del cable para el cable que usted está instalando. No doble el cable más de lo recomendado. No aplique más fuerza de tensión de la recomendada. No aplaste el cable ni permita que se enrosque. El no seguir las recomendaciones del cable puede estropear las características; quizás tendrá que sustituir el cable.</p>

Para información adicional de seguridad,
por favor visite www.corning.com/opcomm/safety.

Sicherheitshinweise

Sicherheitshinweise für Glasfasern

	<p>WARNUNG: Abgetrennte oder kaputte Glasfasern sind sehr scharf und können leicht in die Haut eindringen oder zu Augenverletzungen führen. Keine Glasfaserstücke an Kleidung zurücklassen oder im Arbeitsbereich auf den Boden fallen lassen. Dies kann zu späteren Verletzungen führen. Die Glasfaserstücke mit einer Pinzette aufheben und auf einem eigens dafür verwendeten Stück Klebeband ablegen. Eine gute Organisation ist sehr wichtig.</p>
---	---

Sicherheitshinweise für Chemikalien

	<p>VORSICHT: Die Reinigungsflüssigkeit für Glasfasern kann bei Kontakt mit den Augen zu Augenirritationen führen. Bei Kontakt die Augen sofort mindestens 15 Minuten lang gründlich mit Wasser ausspülen. Die Einatmung von Dämpfen kann schädlich sein. Nur in gut belüfteten Räumen verwenden. Bei Verschlucken Arzt konsultieren.</p>
---	---

Vorsichtsmaßnahmen beim Umgang mit Lasern

	<p>WARNUNG: Nie direkt in das Ende einer Faser schauen, durch die möglicherweise Laserlicht fließt. Laserlicht kann unsichtbar sein und Ihre Augen schädigen. Der direkte Augenkontakt ist nicht schmerzhaft. Anders als bei der Aussetzung mit hellem Licht schließt sich die Iris aber nicht automatisch. Deshalb sind ernste Schäden der Netzhaut möglich. Bei Verdacht der versehentlichen Aussetzung der Augen sind diese unverzüglich untersuchen zu lassen.</p>
---	---

Sicherheitshinweise für Schutzbrillen

	<p>VORSICHT: Es wird die Verwendung von Schutzbrillen empfohlen, die ANSI Z87 entsprechen, um die Augen beim Umgang mit Chemikalien, Kabeln oder Fasern vor Unfällen zu schützen. Glasfaserstücke sind sehr scharf und können die Augen schädigen.</p>
---	---

Sicherheit im Umgang mit Lasern

	<p>Das leistungsstarke UniCam® Installationswerkzeug entspricht den Anforderungen in IEC 60825-1:1993 samt Zusätzen 1:1997 und 2:2001. $P_{max} < 1.0 \text{ mW}$, $\lambda = 635 \text{ nm}$</p> <p style="text-align: center;">LASERLICHT NICHT DIREKT MIT OPTISCHEN INSTRUMENTEN ANSCHAUEN (VERGRÖßERUNGSGLÄSER) LASERPRODUKT KLASSE 1M</p> <p>Vorsicht: Alle anderen Bedienungen, Einstellungen oder Verfahren als die hier Beschriebenen, können zu gefährlicher Strahlung führen.</p>
---	---

Vorsichtsmaßnahmen beim Umgang mit Kabeln

<p>Hinweis: Glasfaserkabel sind anfällig gegenüber übermäßigem Ziehen, Biegen und Druck. Bei der Installation von Kabeln ist die jeweilige Kabelspezifikation hinzuzuziehen. Kabel nicht stärker als den empfohlenen minimalen Biegeradius biegen. Kabel nicht stärker als in der Spezifikation angegeben ziehen. Kabel nicht drücken oder knicken. Bei Nichtbeachtung können Schäden auftreten, die die Übertragungseigenschaften des Kabels verändern; eventuell muss das Kabel ersetzt werden.</p>
--

Besuchen Sie bitte www.corning.com/opcomm/safety für weitere Sicherheitsinformationen

Consignes de sécurité

Manipulation de la fibre optique

ATTENTION: Les fibres de verre fendues ou cassées sont très coupantes et peuvent très facilement vous percer la peau ou vous blesser les yeux. Évitez tout résidu de fibre sur vos vêtements ou sur une zone de travail où elle pourraient causer des blessures ultérieurement. Retirez les morceaux de fibres à l'aide d'une pince à épiler et disposez les sur un morceau de bande adhésive réservée à cet effet. Un bon entretien de vos locaux est primordial.

Utilisation des produits chimiques

ATTENTION: Le liquide de nettoyage de fibre optique peut irriter les yeux. En cas de contact, rincer abondamment les yeux à l'eau claire pendant au moins 15 minutes. Inhaler des fumées peut être dangereux. A utiliser dans un local bien aéré. En cas d'ingestion, consultez immédiatement un spécialiste.

Manipulation du laser



WARNING: Ne regardez jamais à l'extrémité d'une fibre qui pourrait émettre un faisceau laser. Le faisceau laser n'est pas forcément visible et peut provoquer des dommages oculaires. Une exposition directe au faisceau est indolore, votre iris ne se ferme pas involontairement comme s'il était exposé à une forte lumière, ce qui pourrait causer des dégâts irréversibles sur la rétine. En cas de doute sur une éventuelle exposition, il est conseillé de se faire examiner dans les plus brefs délais.

Utilisation des lunettes de protection

ATTENTION: Recommandez l'utilisation de lunettes de protection conformes à la norme ANSI Z87, pour protéger les yeux contre toute blessure accidentelle lors de la manipulation de produits chimiques, de câbles ou de fibres. Les morceaux de fibre de verre sont très coupants et peuvent provoquer des dommages oculaires.

Sécurité Laser

L'outil d'installation High-Performance UniCam® est conforme aux exigences de IEC 60825-1:1993 plus Amendements 1:1997 et 2:2001.

$P_{max} < 1.0 \text{ mW}$, $\lambda = 635 \text{ nm}$

**NE REGARDEZ PAS LE RAYONNEMENT LASER DIRECTEMENT
OU A TRAVERS DES INSTRUMENTS OPTIQUES (LOUPES).
PRODUIT LASER DE CLASSE 1**



ATTENTION: L'utilisation de commandes ou de réglages ou l'exécution de procédures autres que ceux et celles spécifiés dans la présente notice risque d'entraîner une exposition à des radiations.

Manipulation des câbles

NOTE: Le câble optique est sensible à l'excès de traction, de courbure et à l'écrasement. Référez vous à la fiche technique du câble que vous installez. Ne pliez pas le câble au delà du rayon de courbure minimum recommandé. Ne poussez pas la traction des câbles au delà des recommandations. N'écrasez pas le câble et évitez qu'il s'entortille. Tous ces gestes malencontreux pourraient altérer les caractéristiques de transmission du câble qui devrait être remplacé.

Pour tout complément d'information, veuillez consulter notre page:
www.corning.com/opcomm/safety

CORNING

Table of Contents

1. Connector Preparation	
1 UniCam® High-Performance Installation Tool	1
2. Fiber Preparation	
2-A 900 µm Tight-Buffered Fiber.....	5
2-B Fan-Out Kit Tubing	9
2-C Jacketed Cable.....	13
3. Fiber Cleaving	
3-A 900 µm Tight-Buffered Fiber.....	17
3-B Fan-Out Kit Tubing	19
3-C Jacketed Cable.....	21
4. Connector Termination	
4-A 900 µm Tight-Buffered Fiber and Fan-Out Kit Tubing	23
4-B Jacketed Cable.....	29
5. Maintenance and Troubleshooting	
5-A Maintenance for Installation Tool and FBC-007 Cleaver.....	35
5-B Troubleshooting Resources.....	43

Inhaltsverzeichnis

1. Vorbereitung der Stecker	
1 High-Performance UniCam® Werkzeugset.....	1
2. Vorbereitung der Faser	
2-A 900 µm Festader	5
2-B Fan-Out Aufteiladapter	9
2-C Kabel	13
3. Fasern trennen	
3-A 900 µm Festader	17
3-B Fan-Out Aufteiladapter	19
3-C Kabel	21
4. Konfektionierung der Stecker	
4-A 900 µm Festader und Fan-Out Kabelaufteiladapter.....	23
4-B Kabel	29
5. Instandhaltung und Fehlerbeseitigung	
5-A Instandhaltung für Werkzeug und FBC-007 Trenngerät.....	35
5-B Fehlerbeseitigung.....	43

Sommaire

1. Préparation des connecteurs	
1 Trousse High-Performance UniCam®	1
2. Préparation de la fibre optique	
2-A Fibre à gaine intermédiaire de 900 µm.....	5
2-B Kit d'épanouissement	9
2-C Câble gainé	13
3. Coupe de la fibre	
3-A Fibre à gaine intermédiaire de 900 µm.....	17
3-B Kit d'épanouissement	19
3-C Câble gainé	21
4. Installation des connecteurs	
4-A Fibre à gaine intermédiaire de 900 µm et Kit d'épanouissement	23
4-B Câble gainé	29
5. Maintenance et dépannage	
5-A Maintenance pour kit d'installation et cleaver FBC-007	35
5-B Dépannage	43

Contenido

1. Preparación del conector	
1 Instalación de la herramienta de Alto desempeño UniCam®	1
2. Preparación de la fibra	
2-A Fibra buffer de 900 µm	5
2-B Fibra en Fan-Out Kit.....	9
2-C Cable con Cubierta.....	13
3. Corte de Fibra	
3-A Fibra buffer de 900 µm	17
3-B Fibra en Fan-Out Kit.....	19
3-C Cable con Cubierta.....	21
4. Instalación del conector	
4-A Fibra buffer de 900 µm y tubo de Fan-Out Kit	23
4-B Cable con Cubierta.....	29
5. Mantenimiento, detección y solución de fallas	
5-A Mantenimiento de la herramienta de instalación y cortadora FBC-007	35
5-B Detección y solución de fallas	43

CORNING

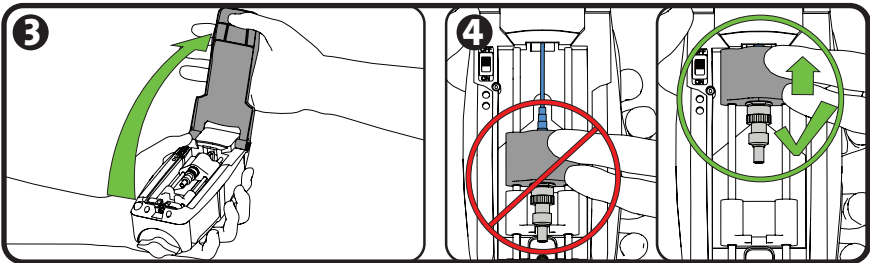
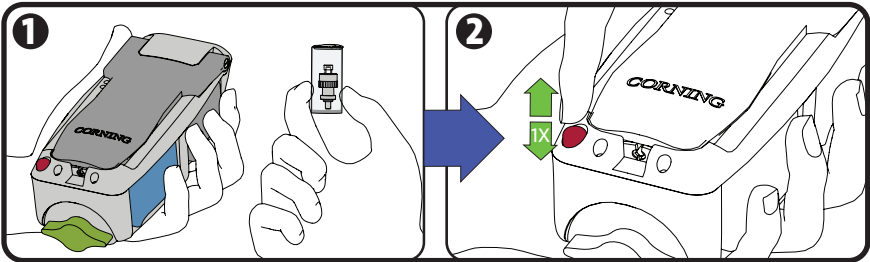
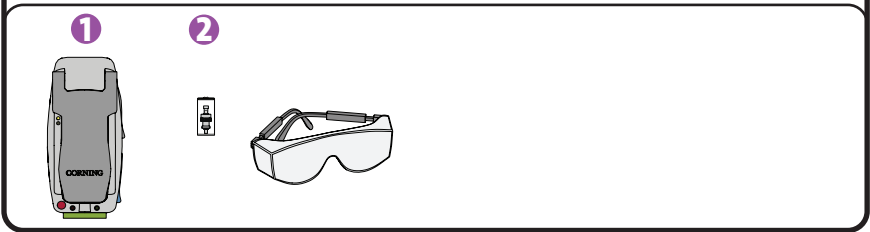
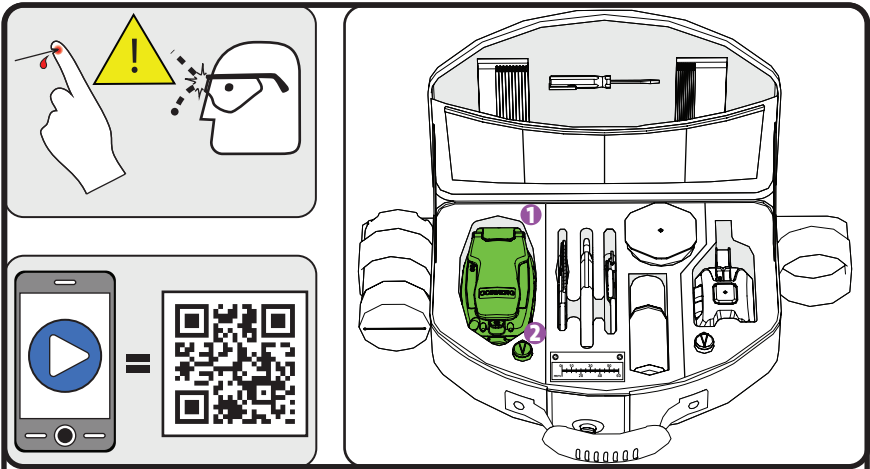

Connector Preparation - UniCam® High-Performance Installation Tool

1

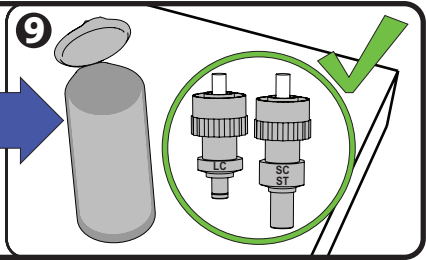
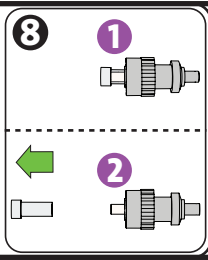
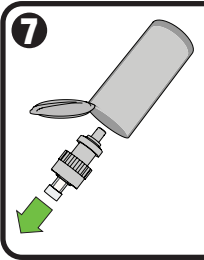
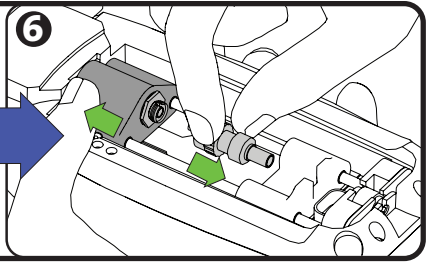
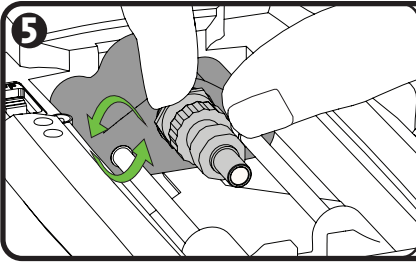

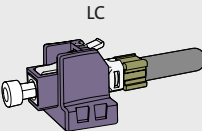
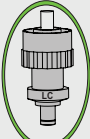

10

A →  =  

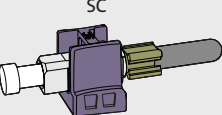
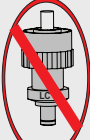
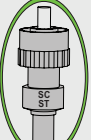

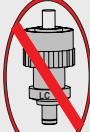
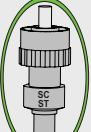
B →  =  

C →  =  

LC

SC

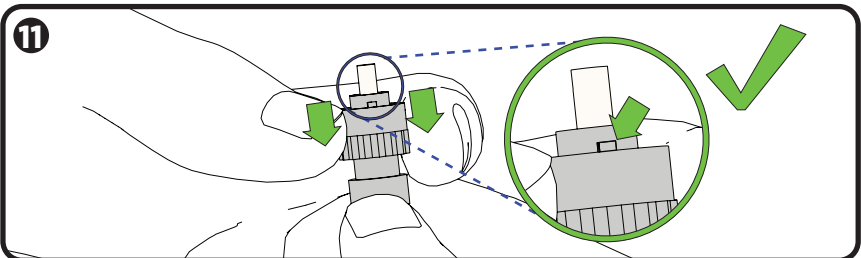
ST®Compatible



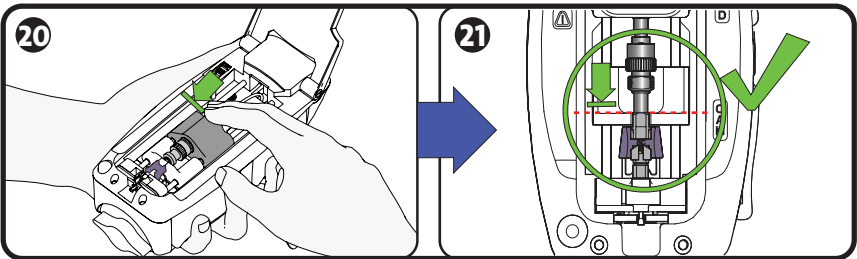
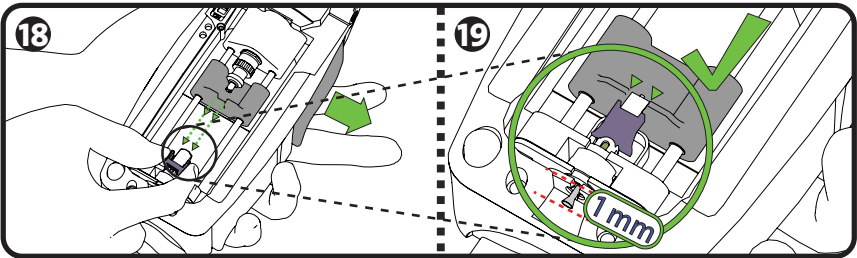
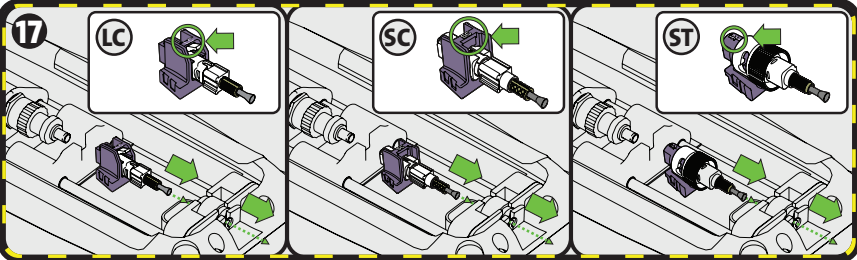
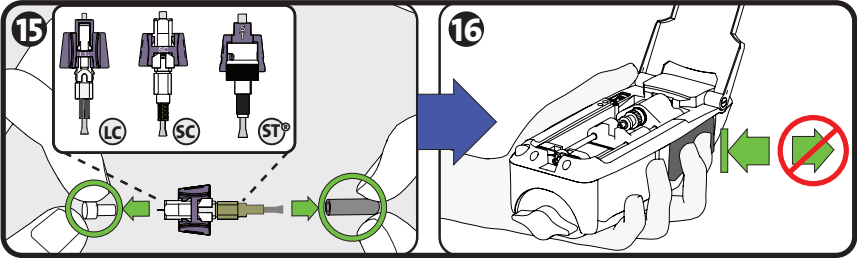
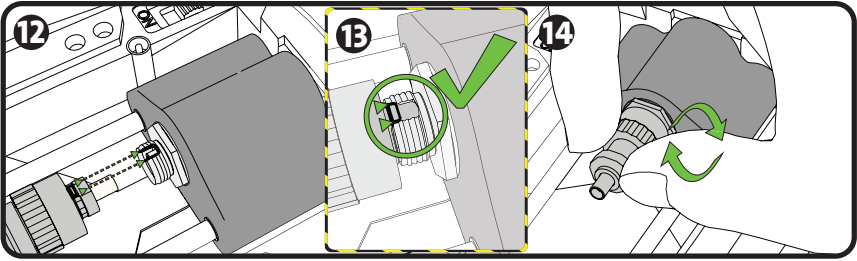

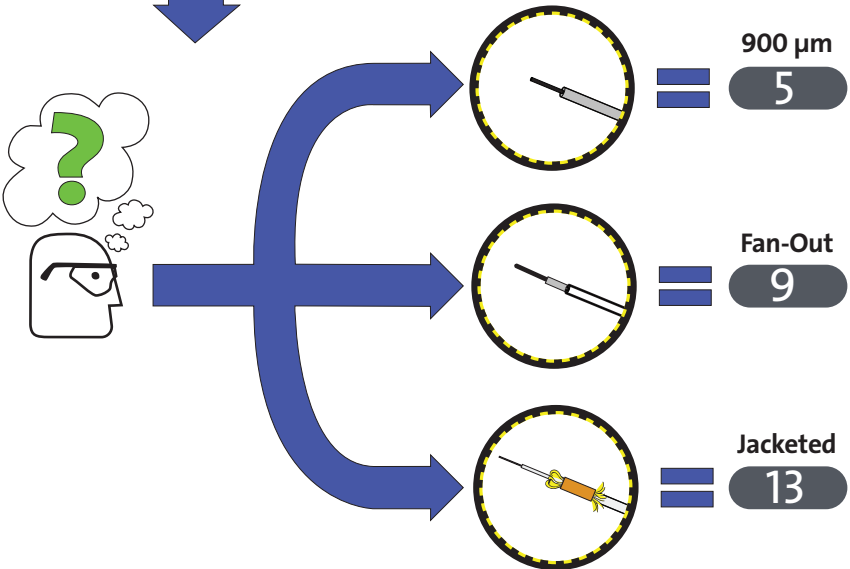
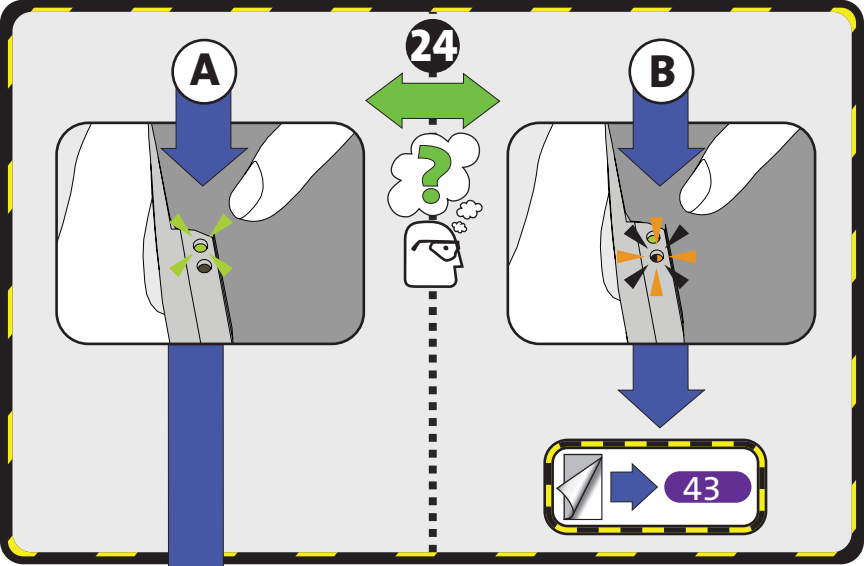
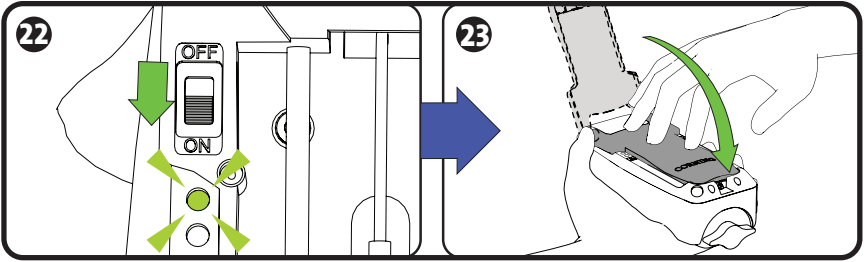

CORNING

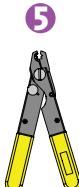
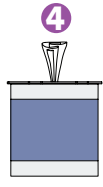
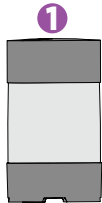
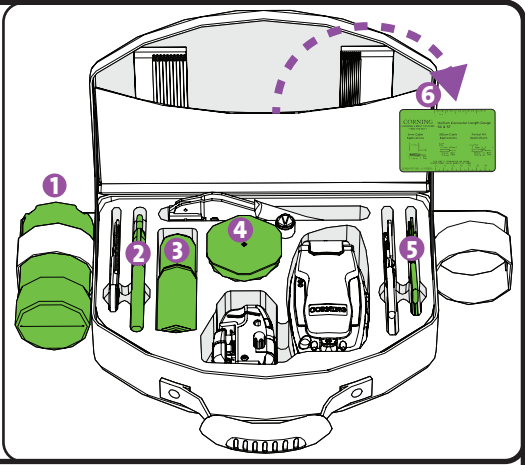
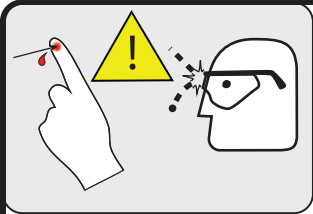

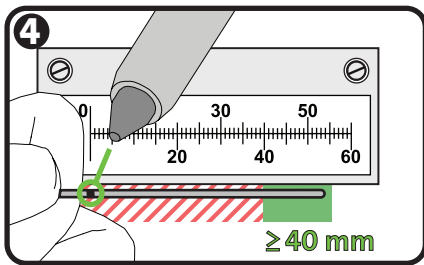
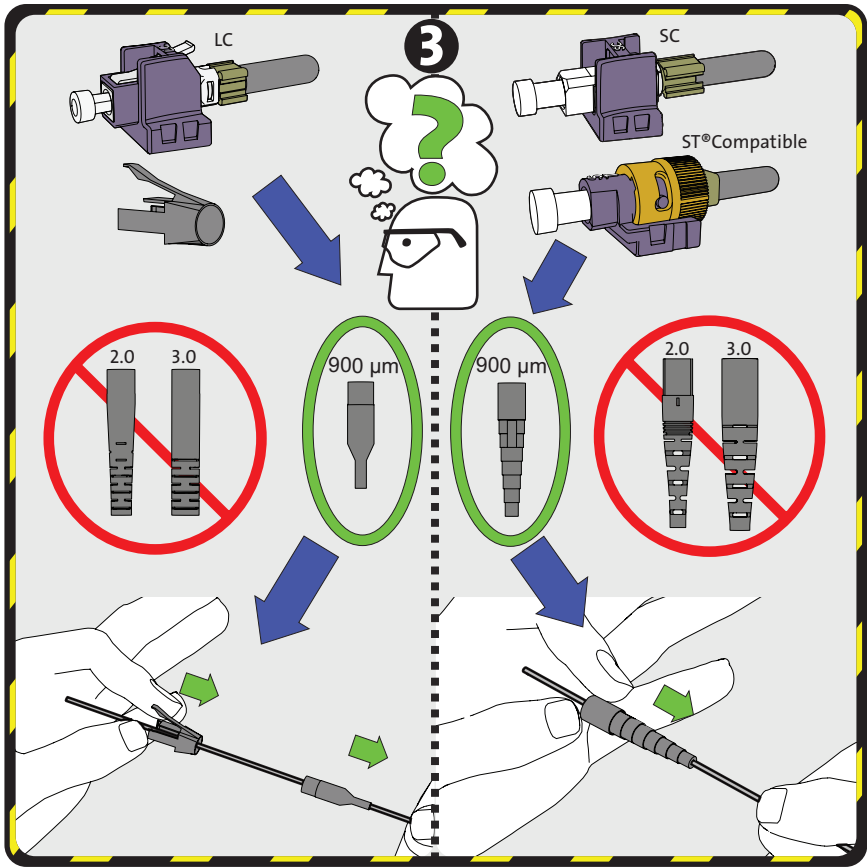

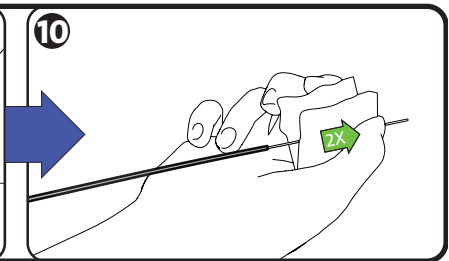
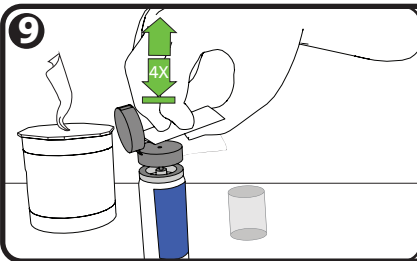
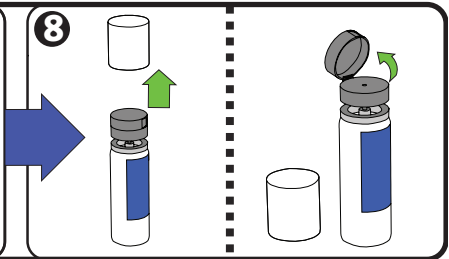
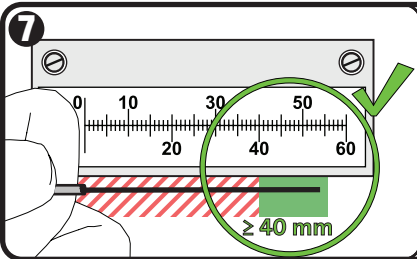
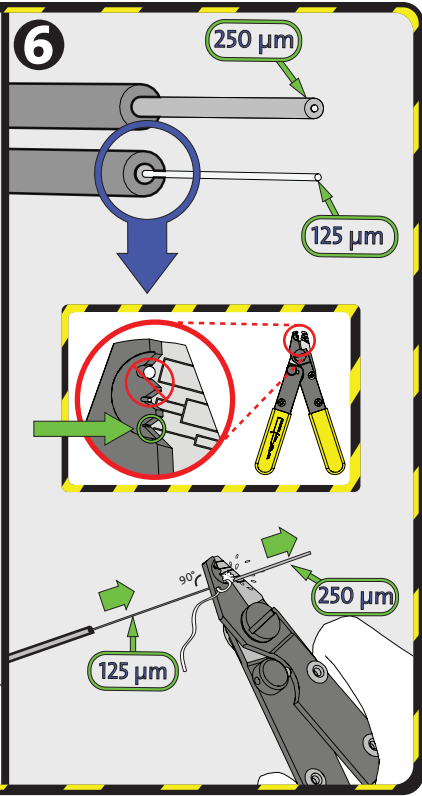
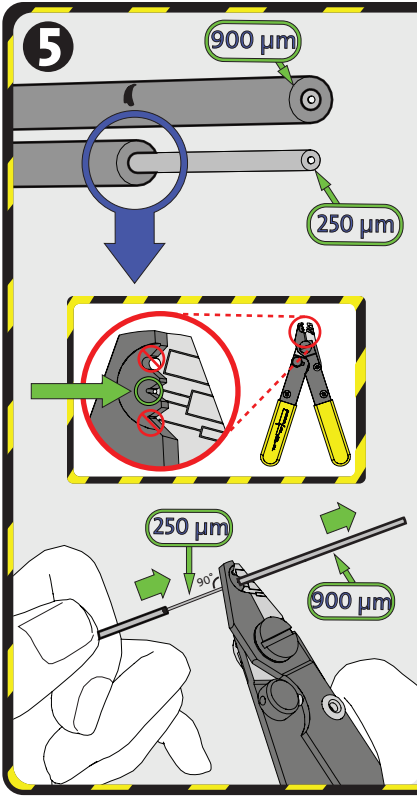

CORNING

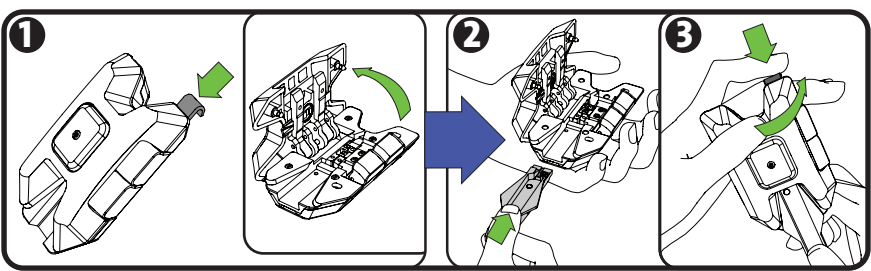
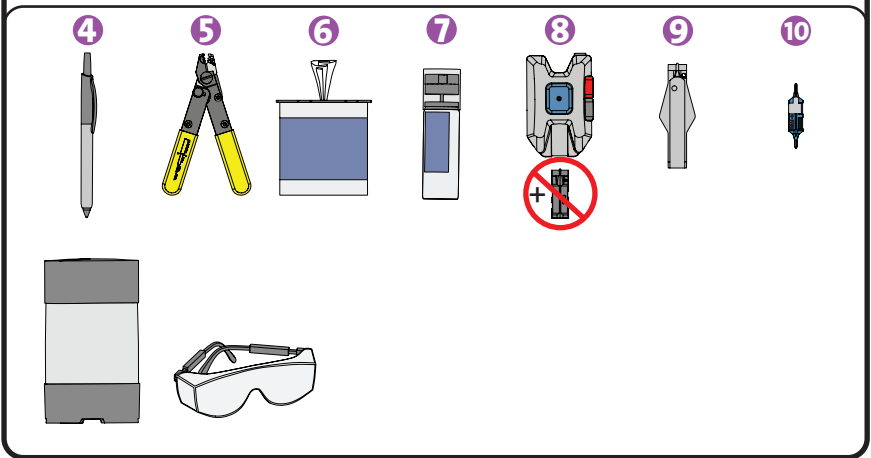
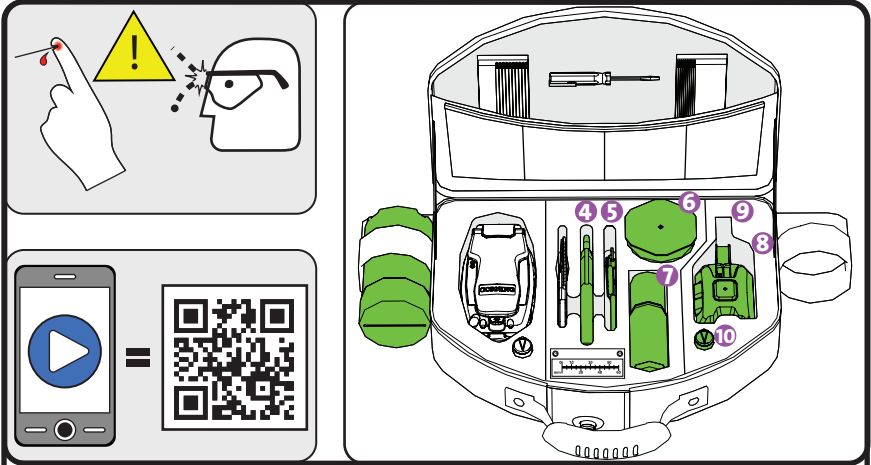

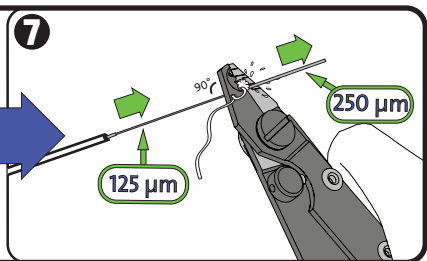
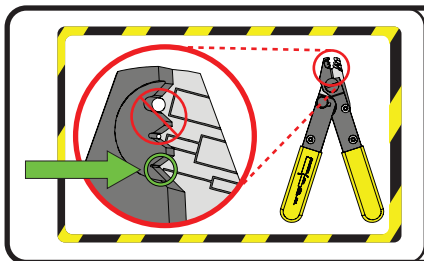
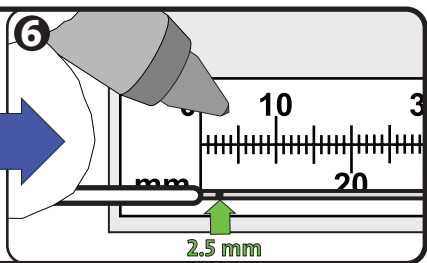
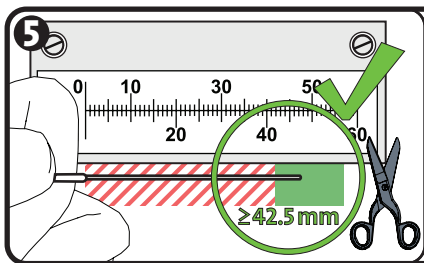
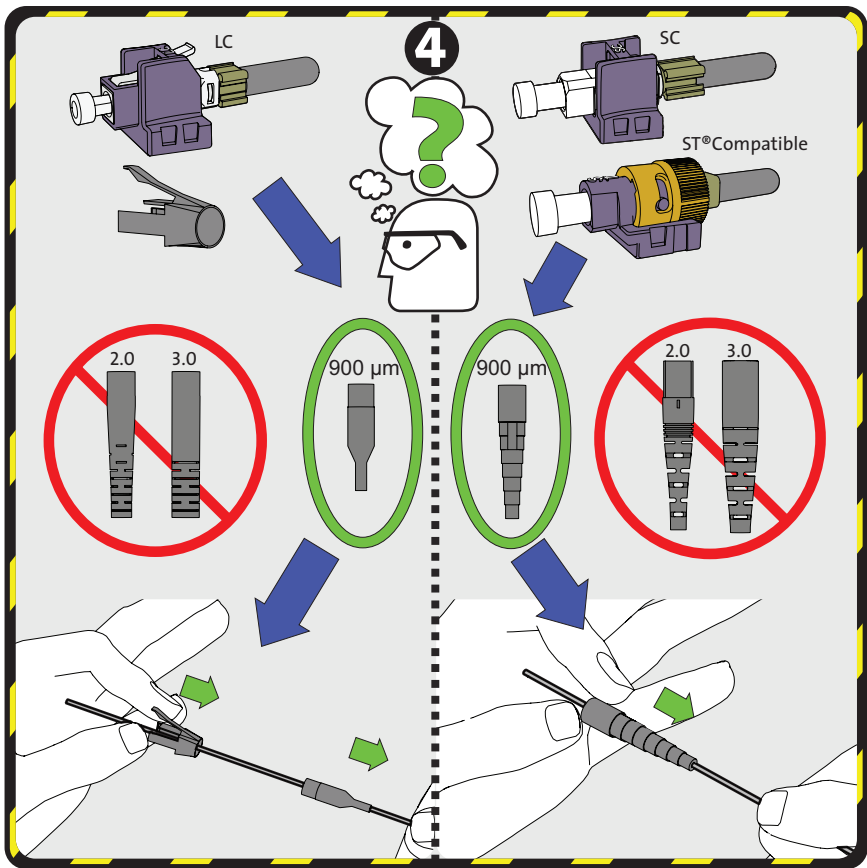

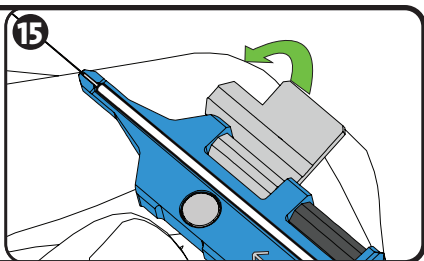
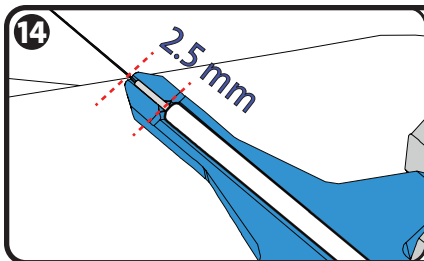
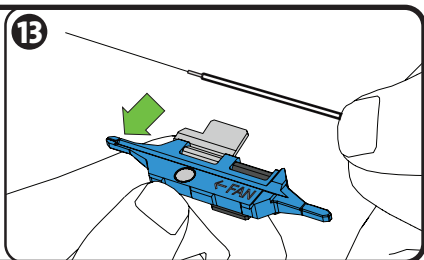
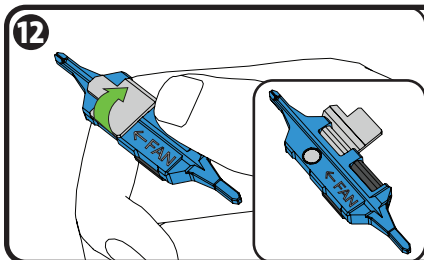
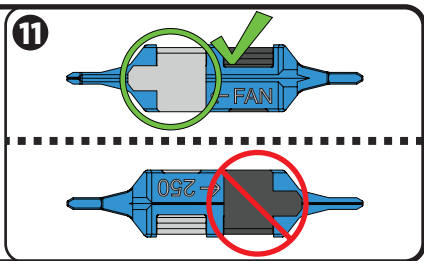
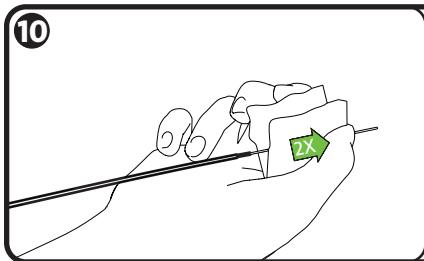
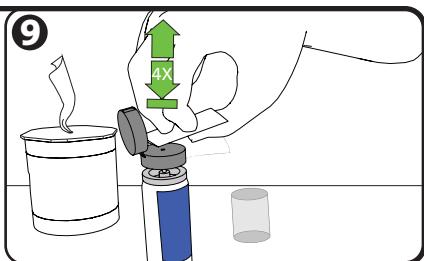
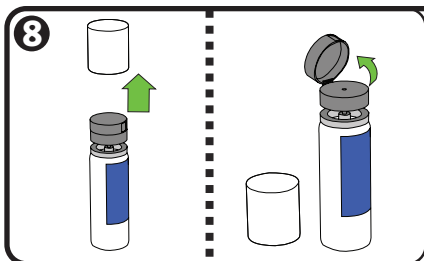

CORNING

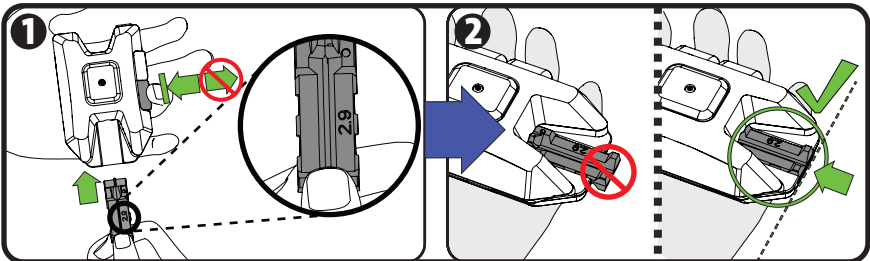
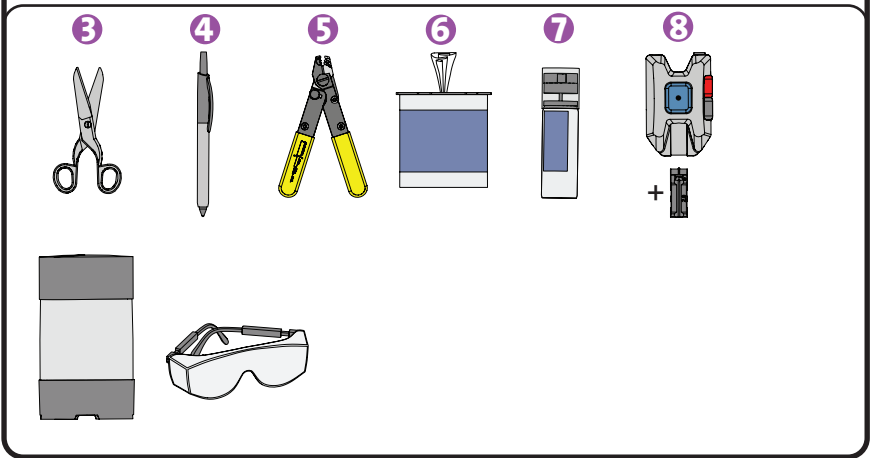
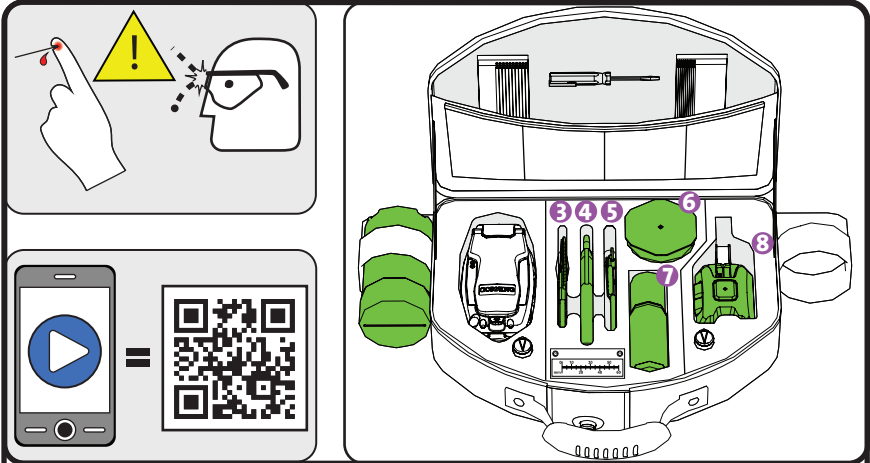

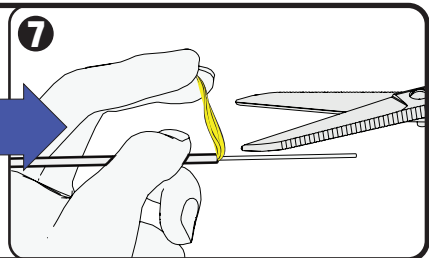
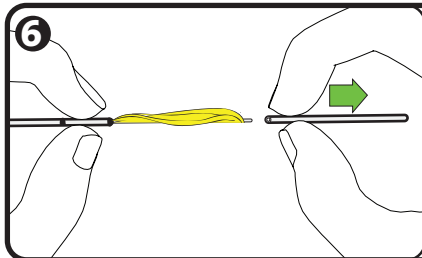
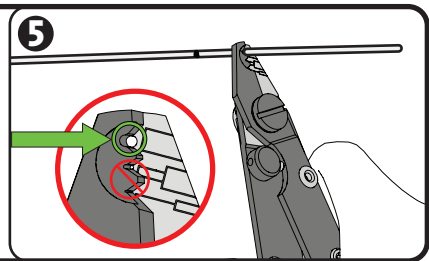
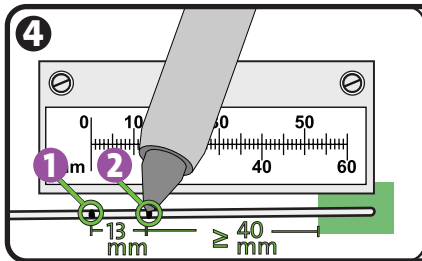
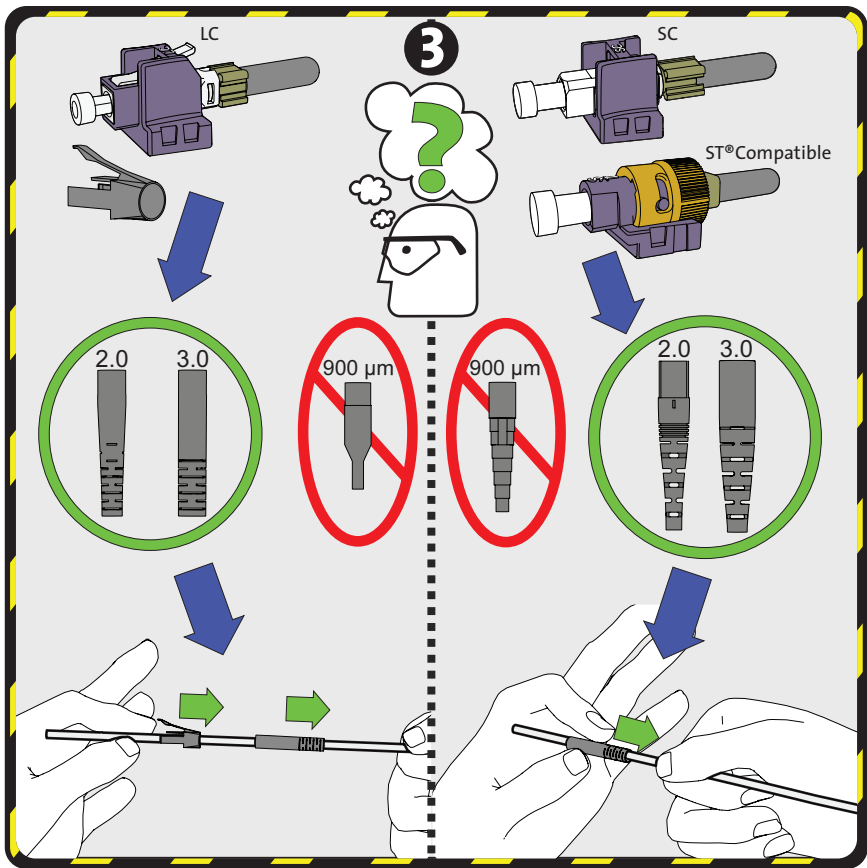

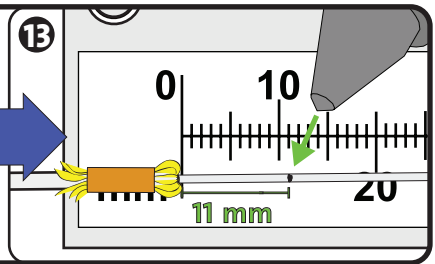
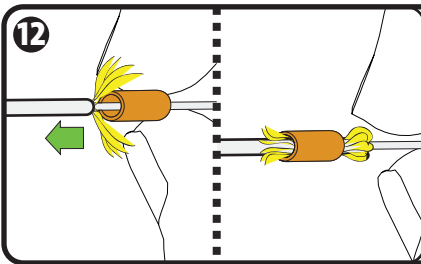
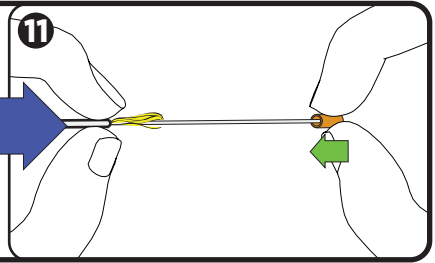
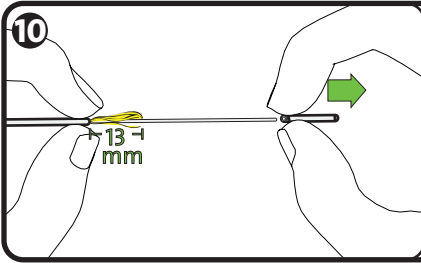
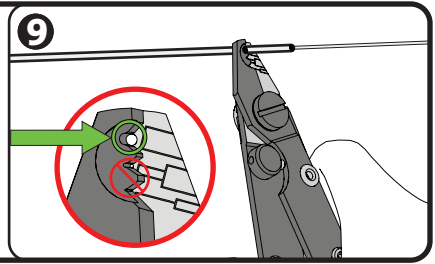
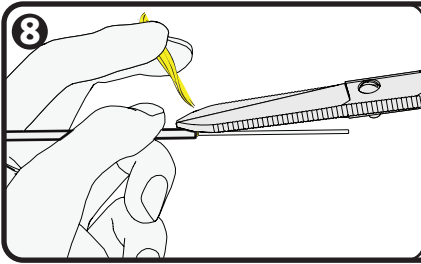

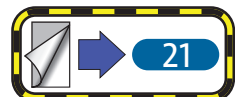
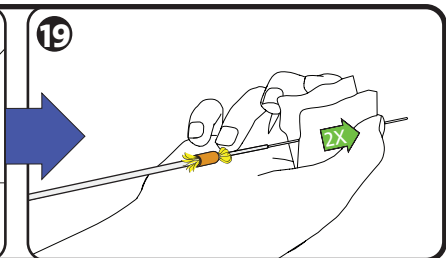
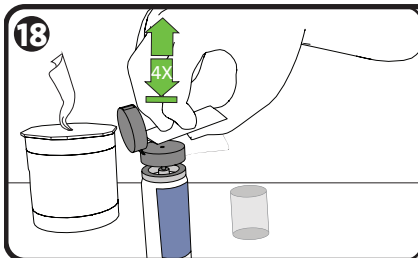
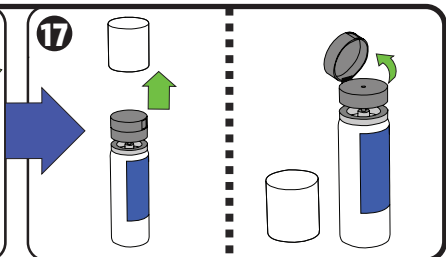
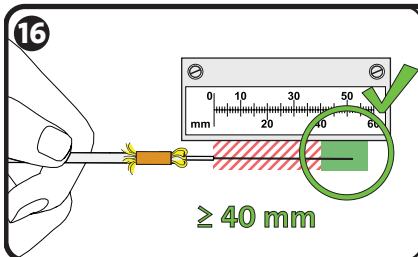
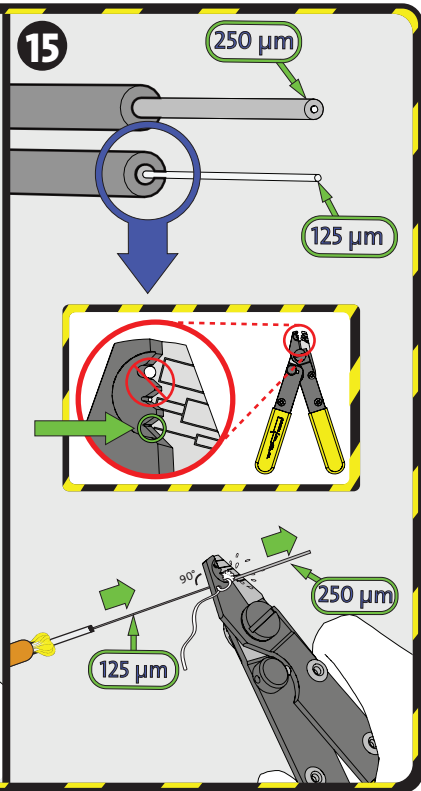
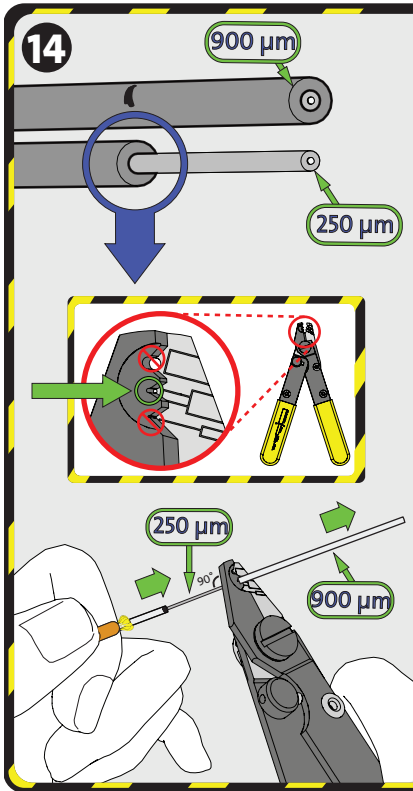

CORNING

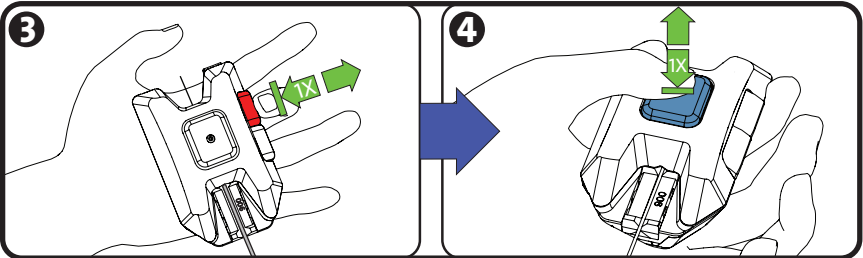
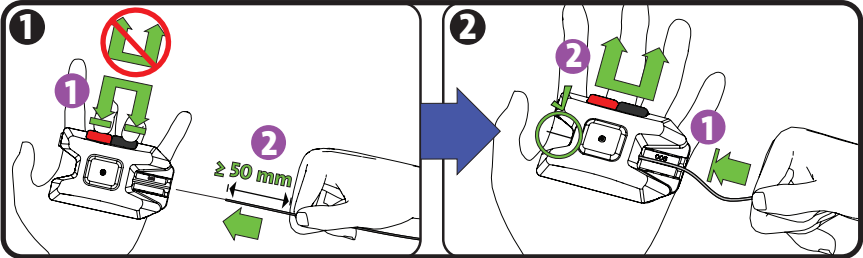
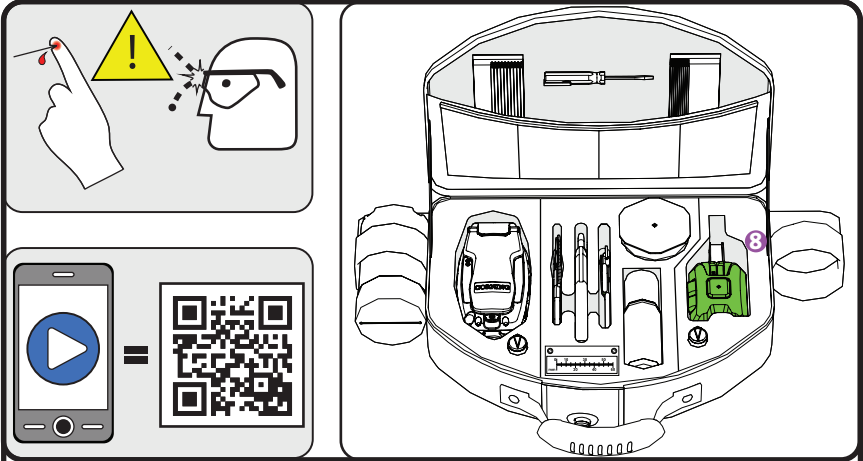

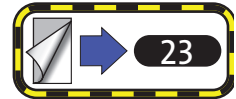
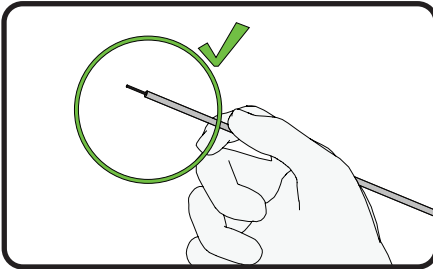
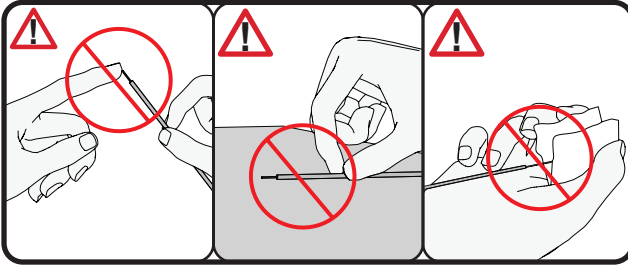
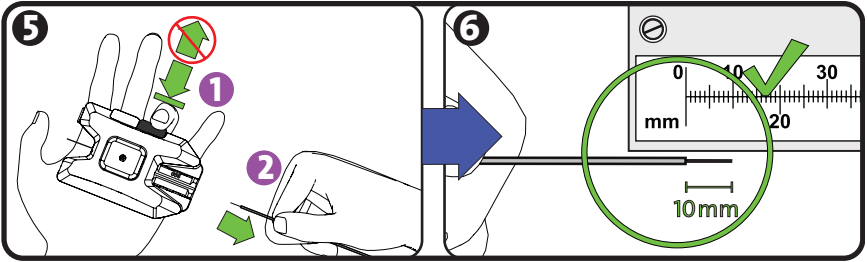

CORNING

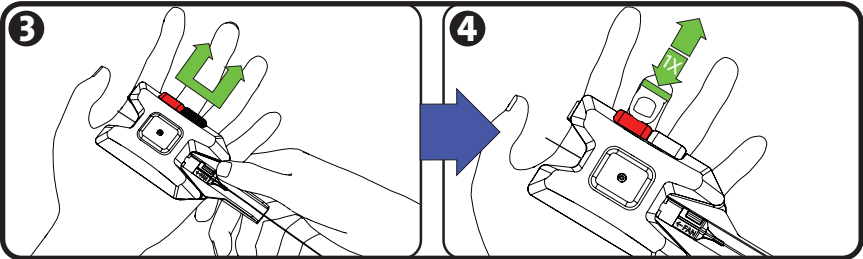
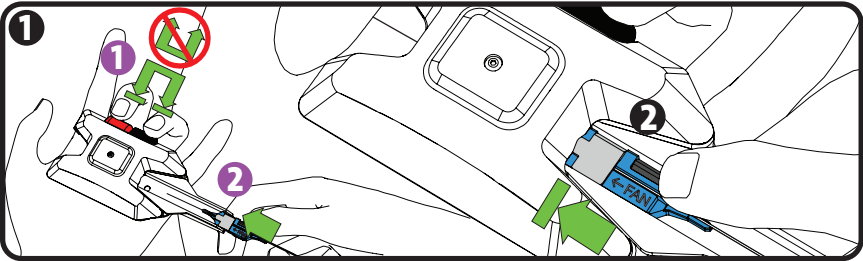
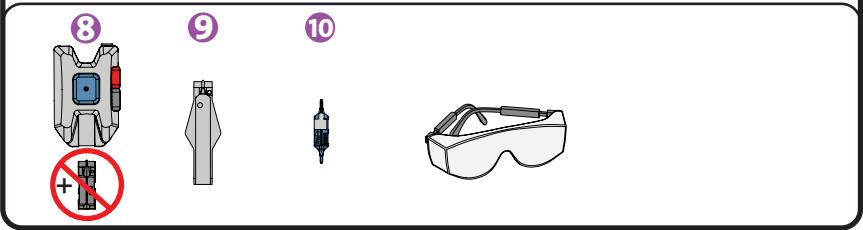
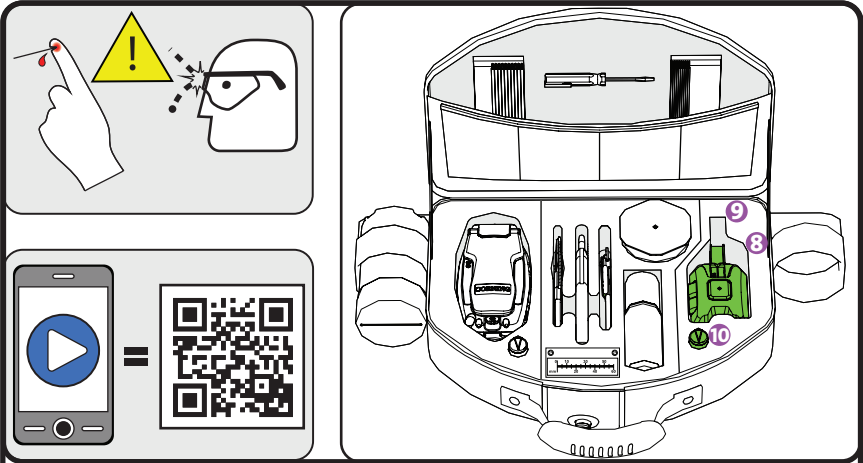

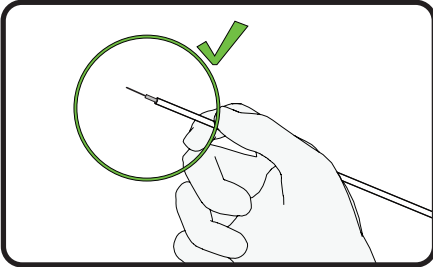
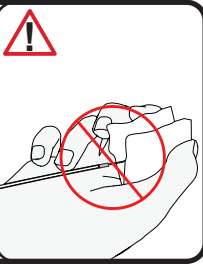
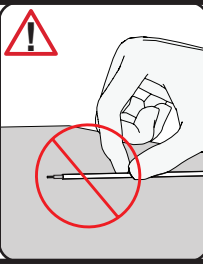
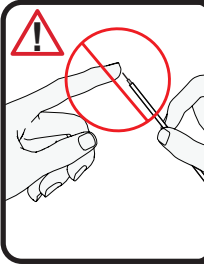
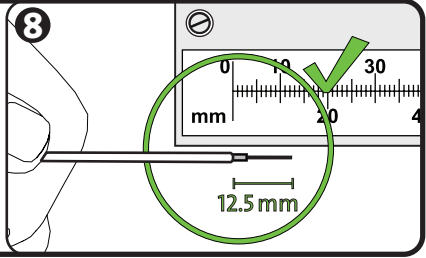
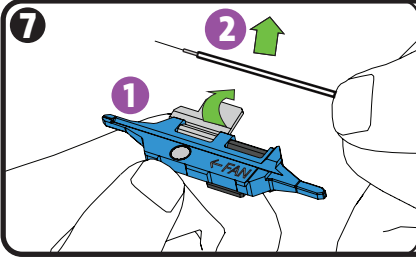
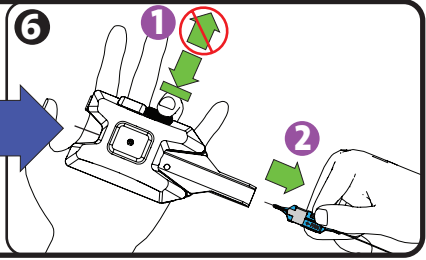
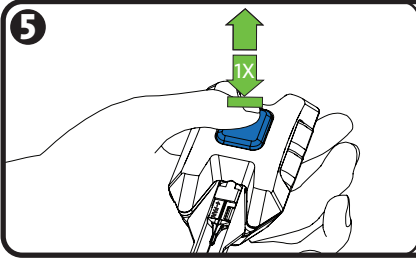

CORNING

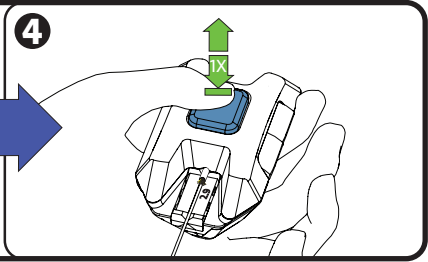
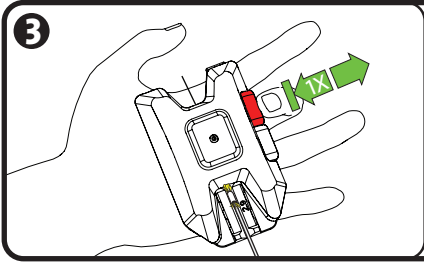
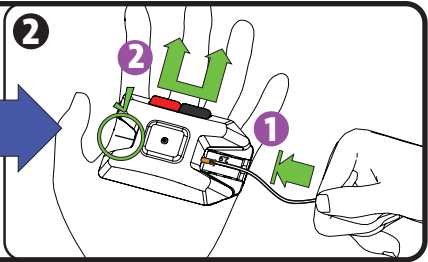
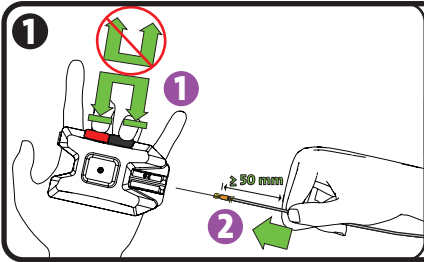
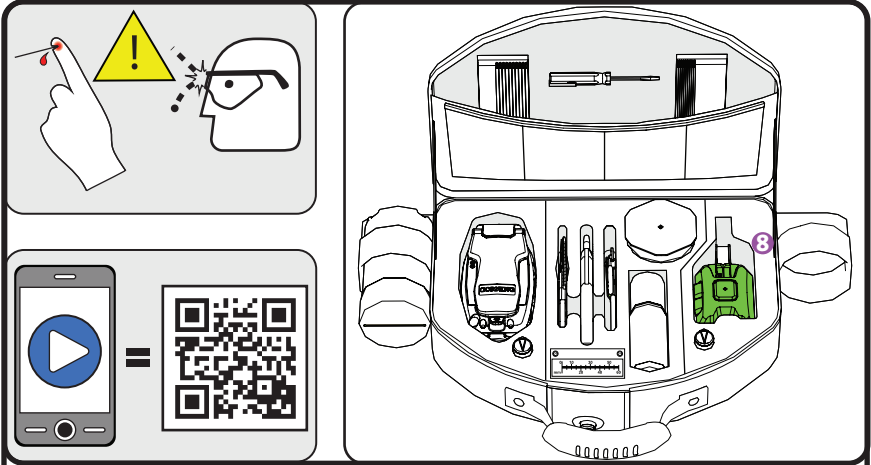

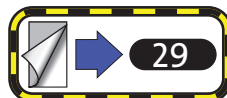
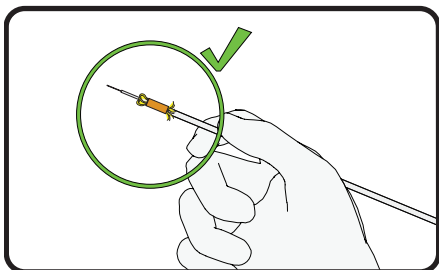
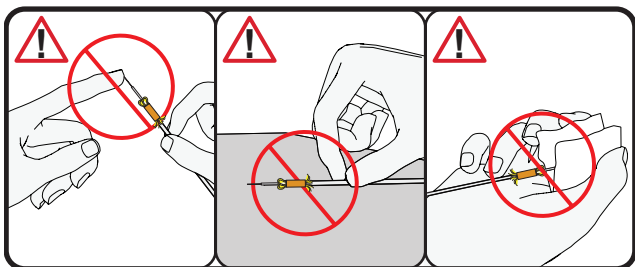
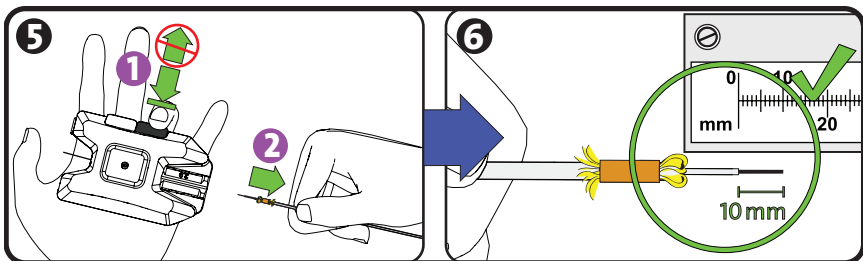

CORNING

Connector Termination - 900 μ m Tight-Buffered Fiber and Fan-Out Kit Tubing

4-A

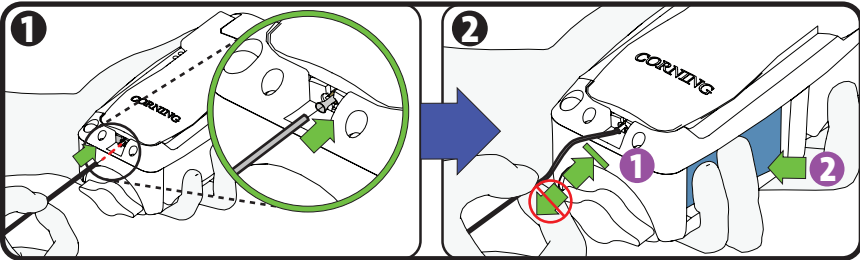
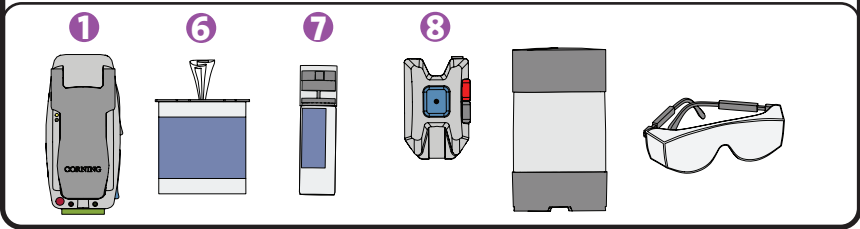
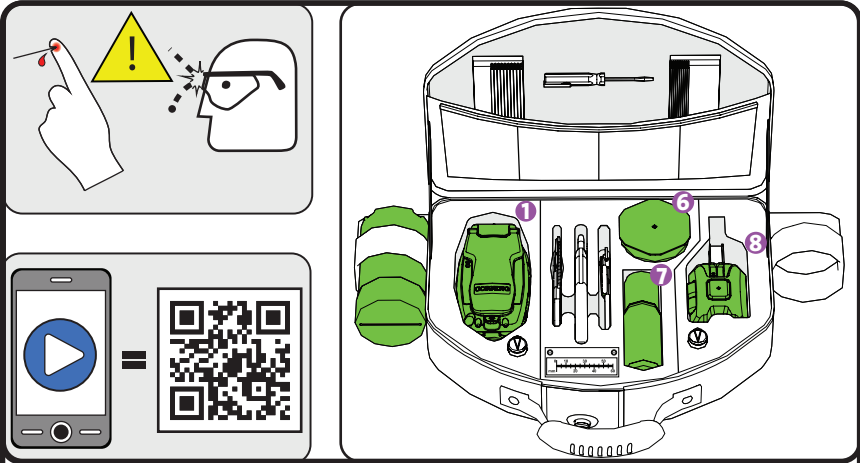

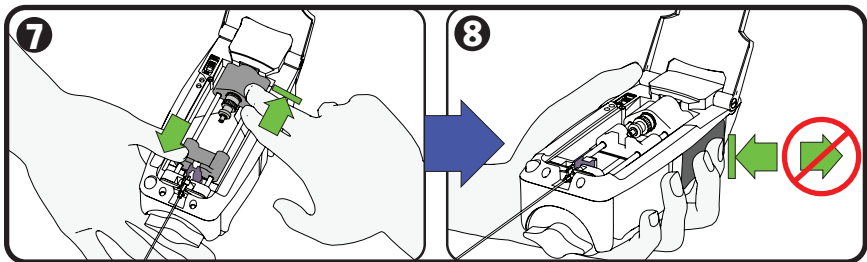
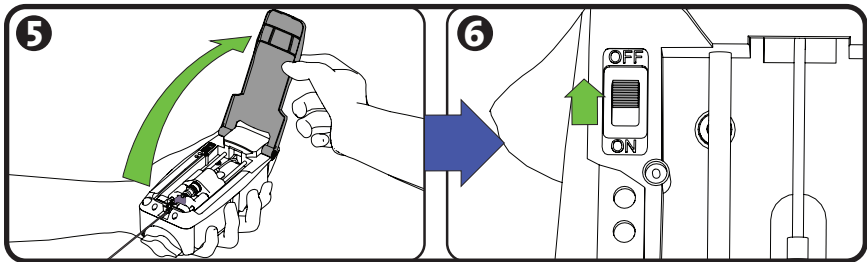
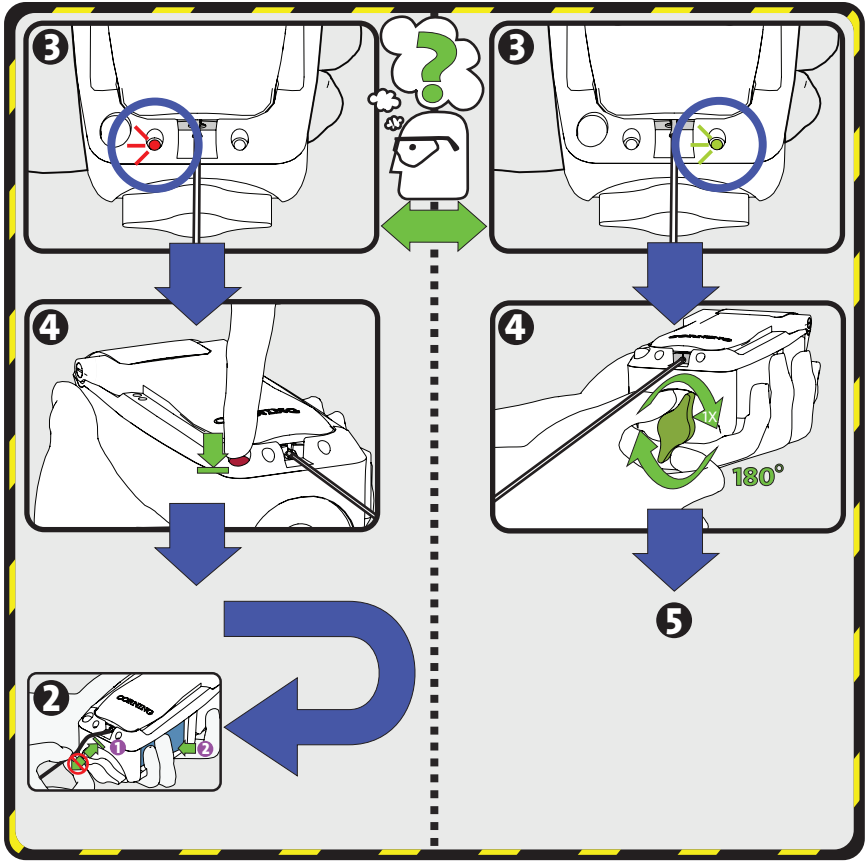

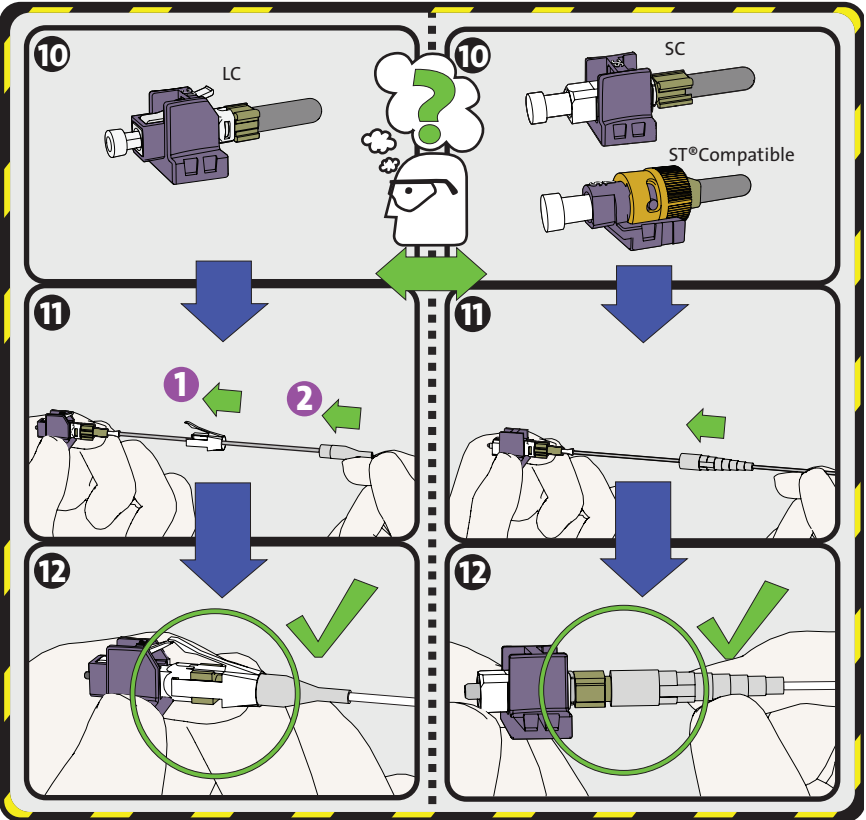
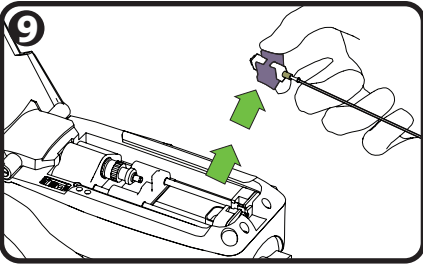

13

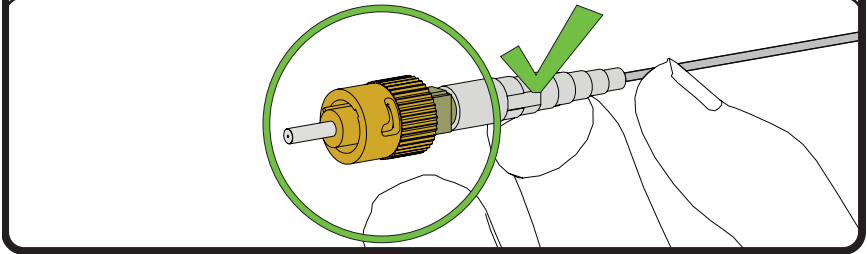
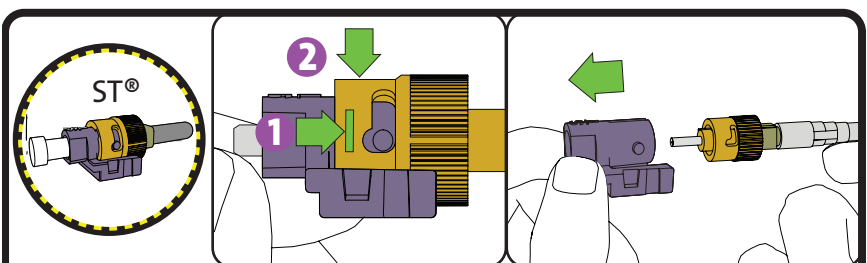
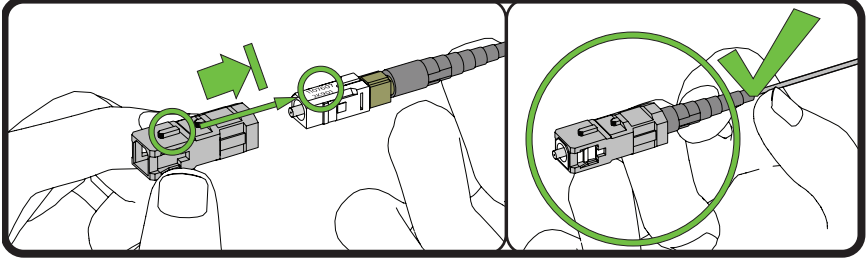
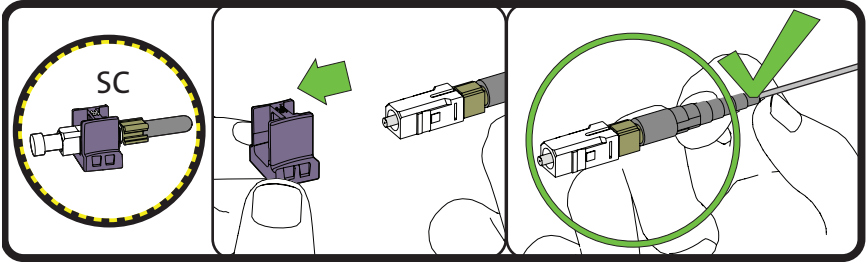
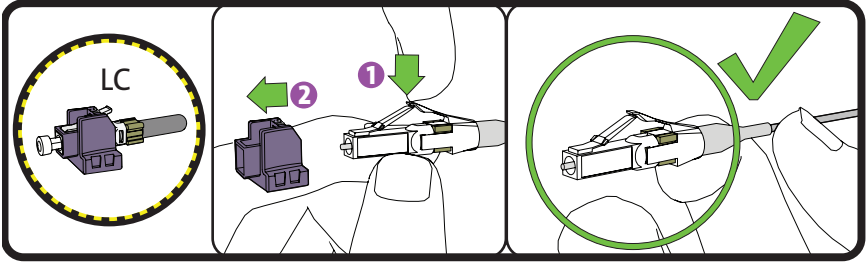

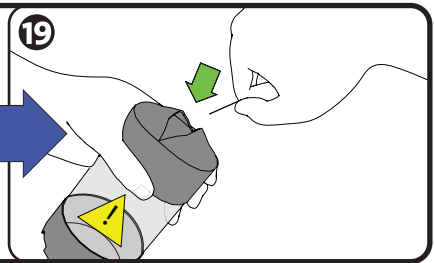
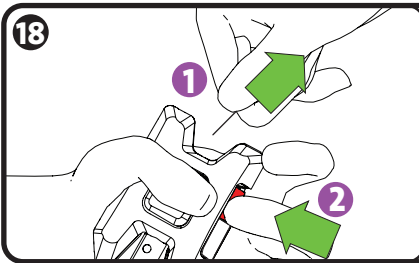
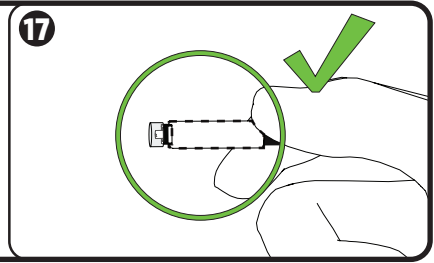
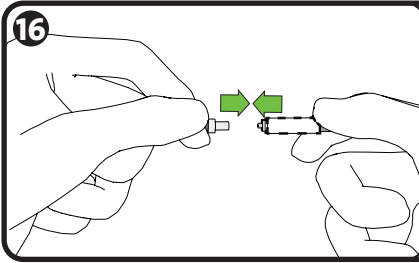
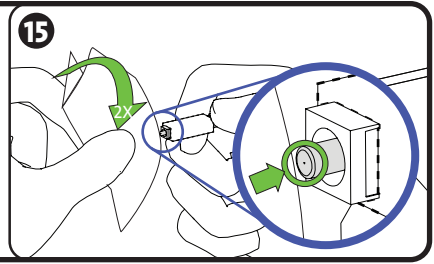
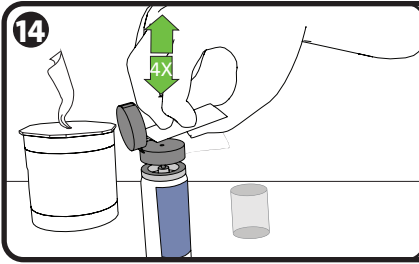

CORNING

Connector Termination - Jacketed Cable

4-B

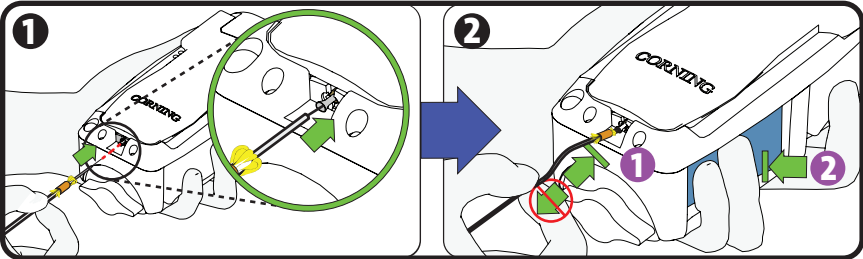
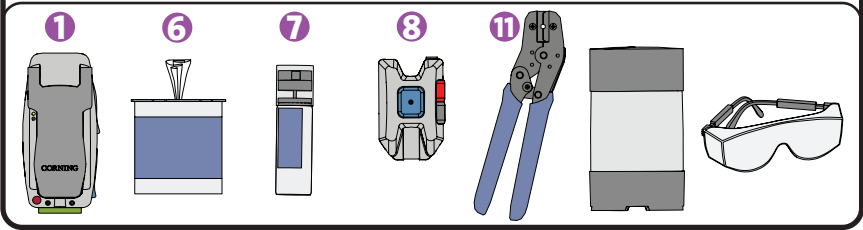
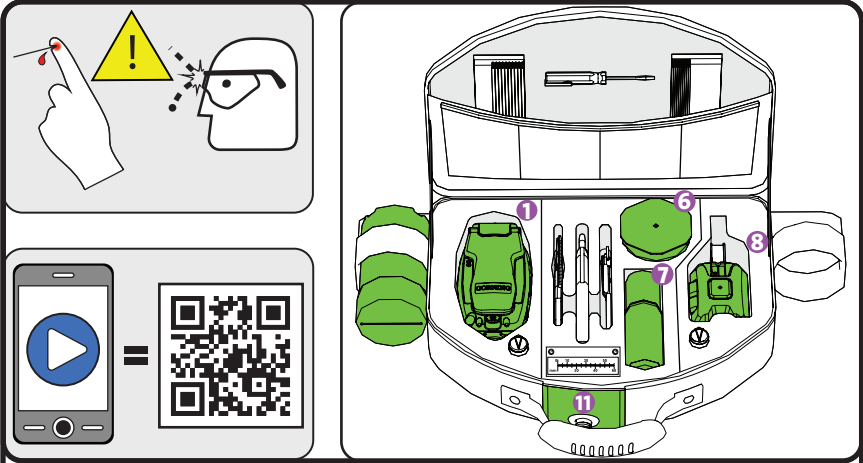

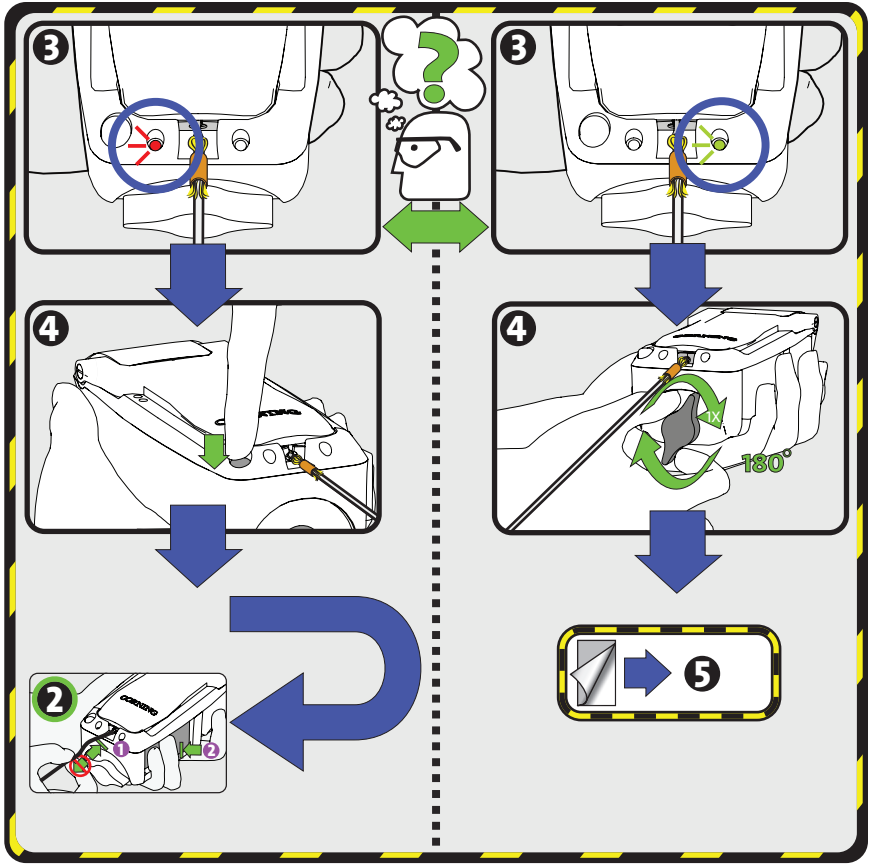

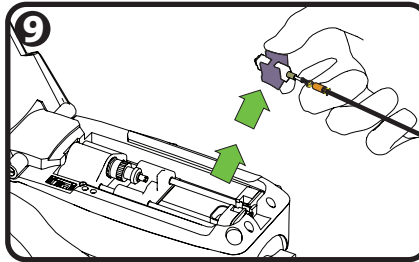
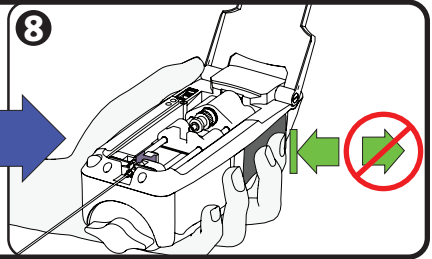
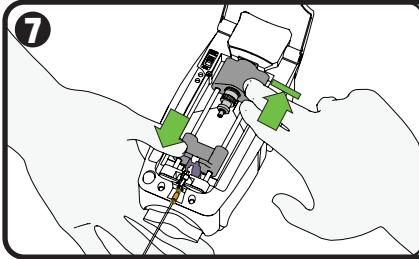
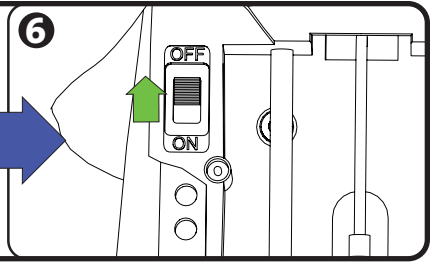
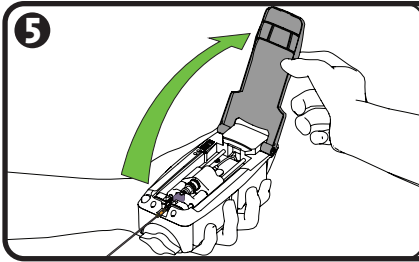

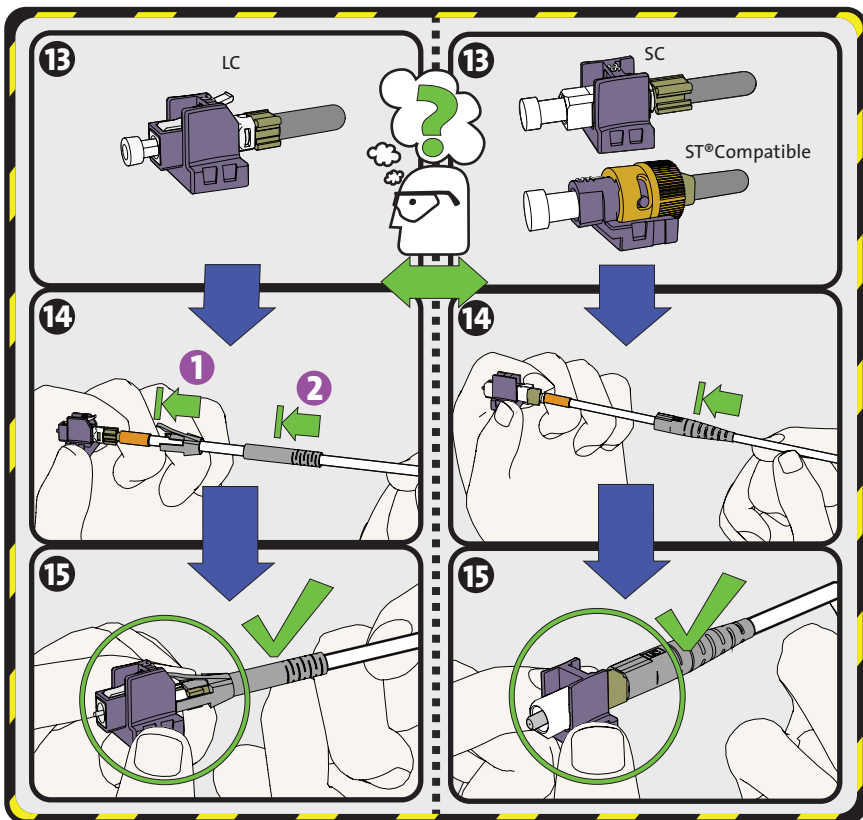
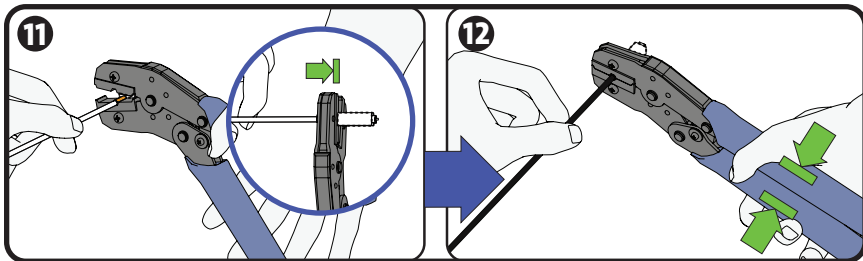
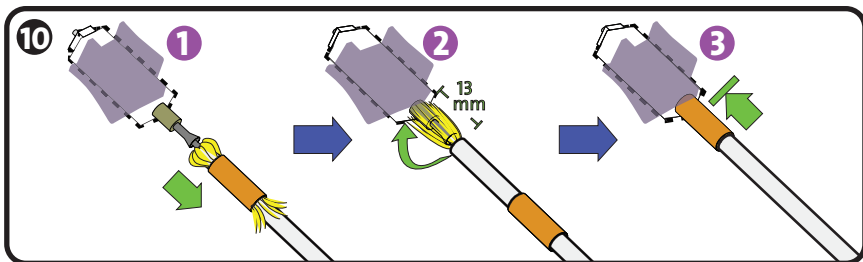

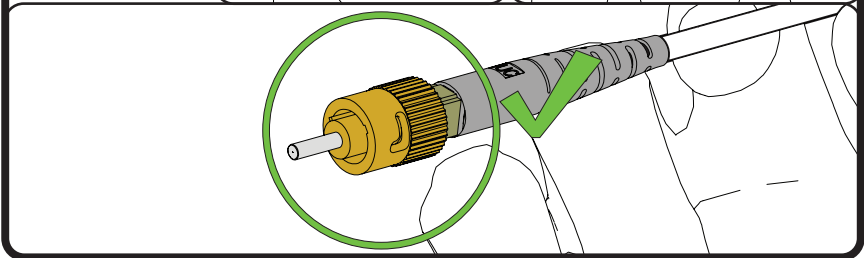
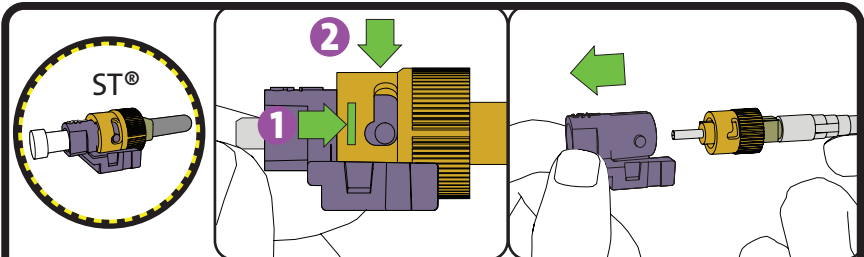
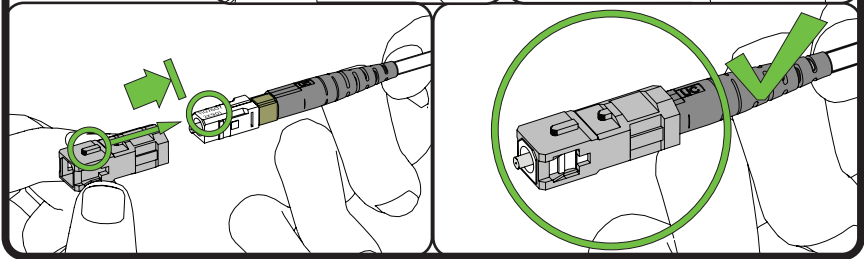
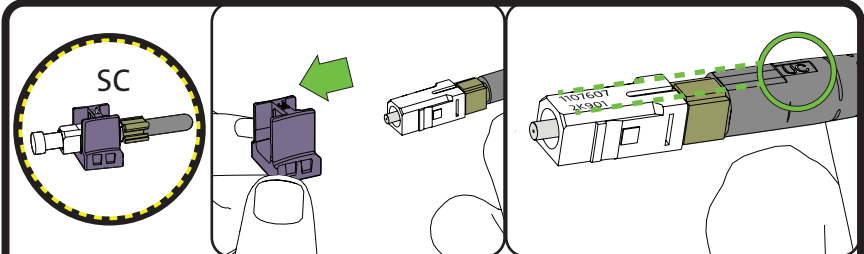
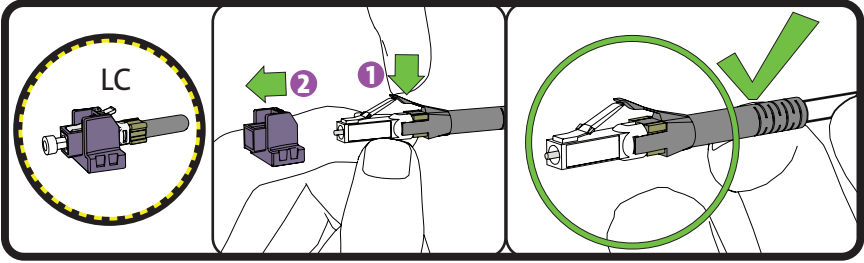

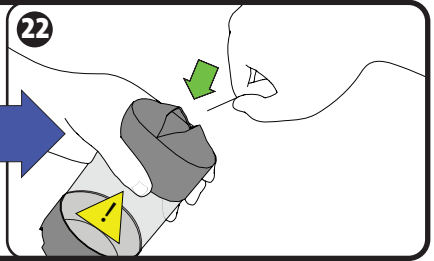
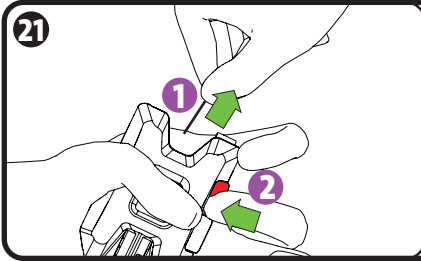
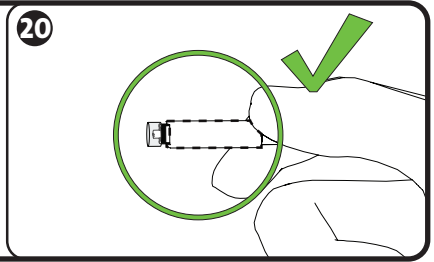
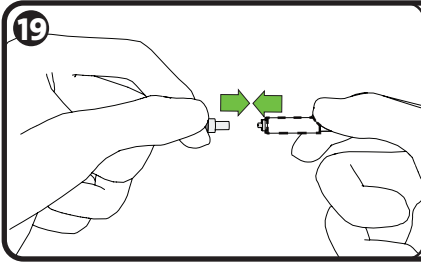
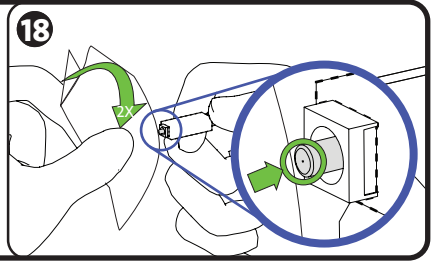
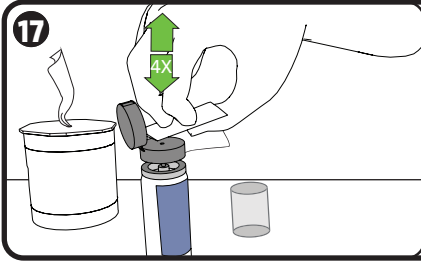

CORNING

Maintenance and Troubleshooting

Maintenance for Installation Tool and FBC-007 Cleaver

Changing Batteries for the Installation Tool

5-A

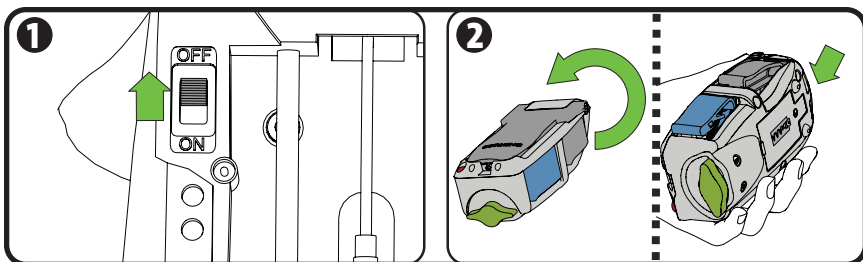
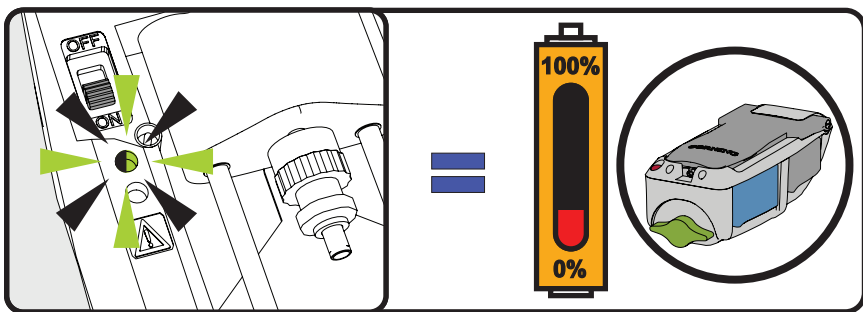
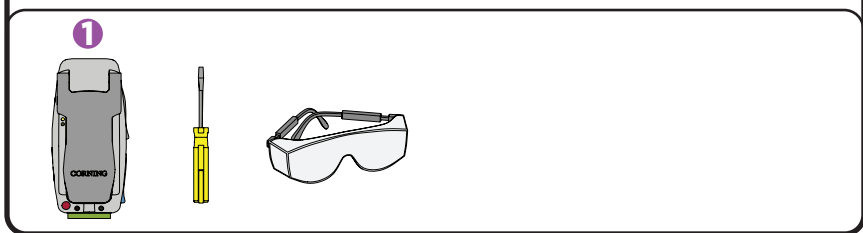
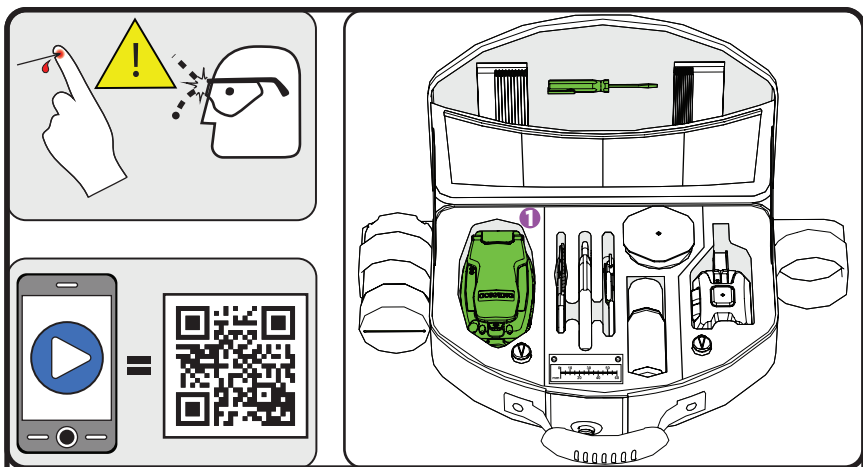

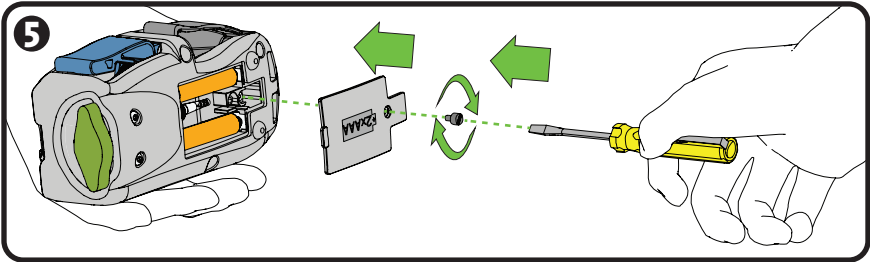
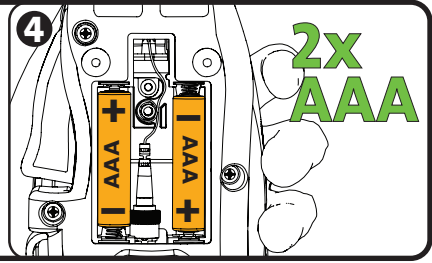
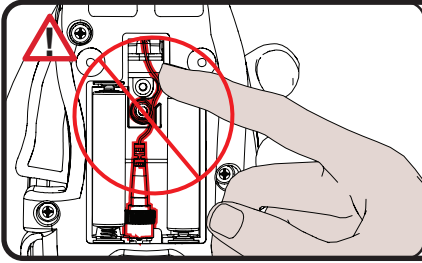
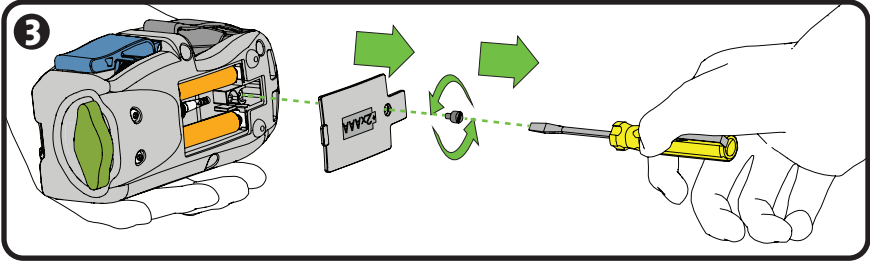

Cleaning the Installation Tool

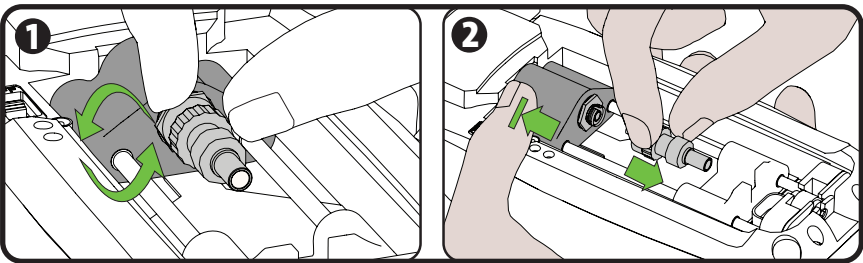
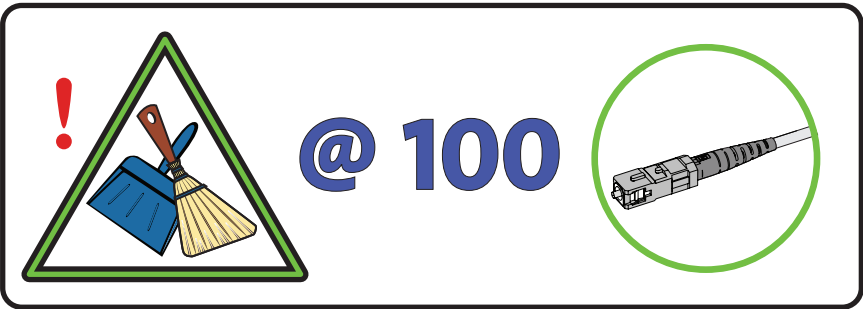
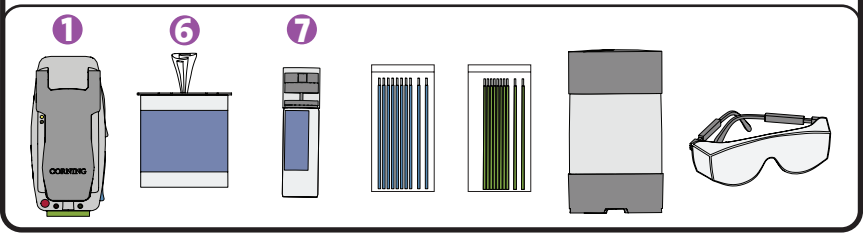
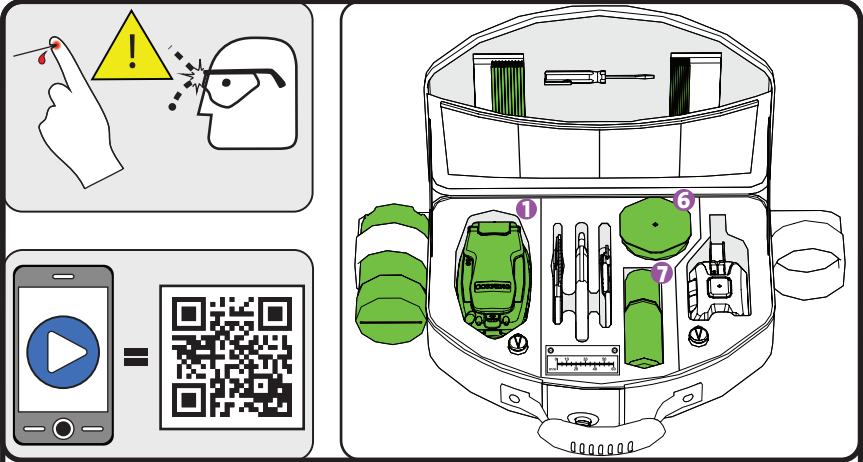

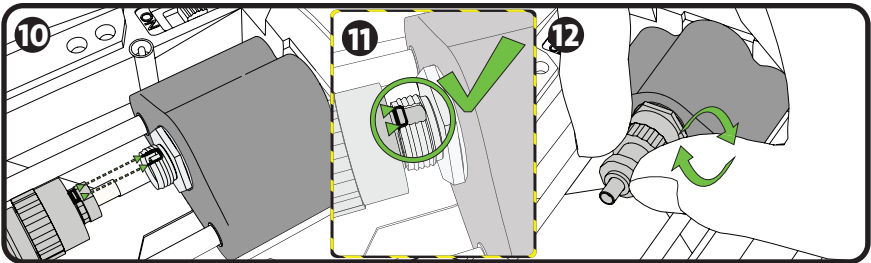
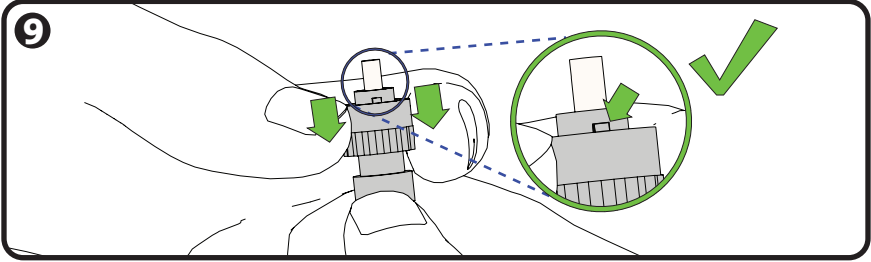
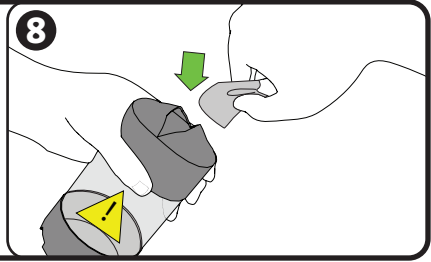
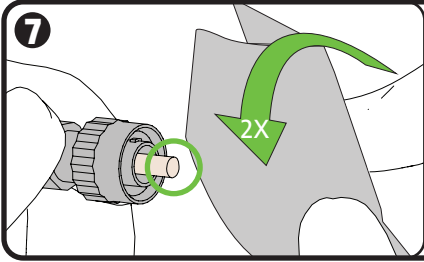
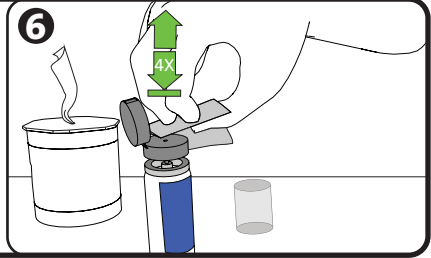
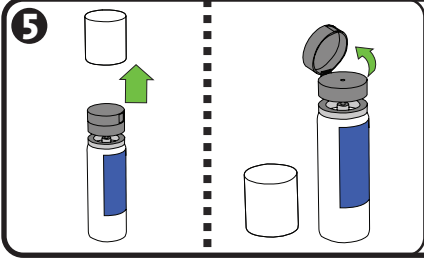
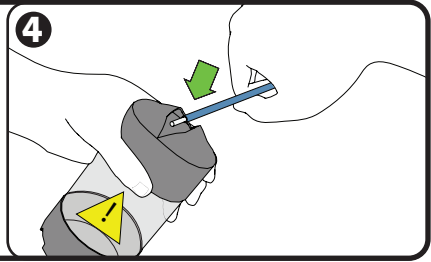
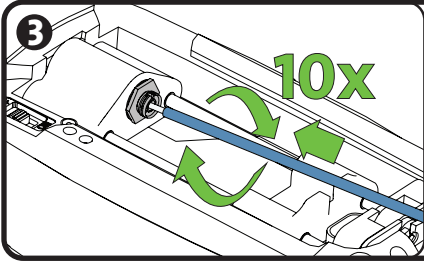

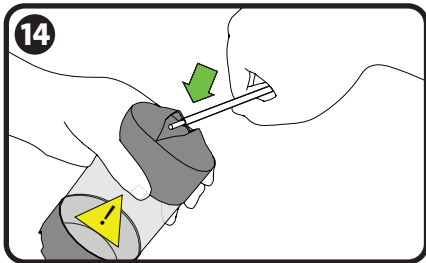
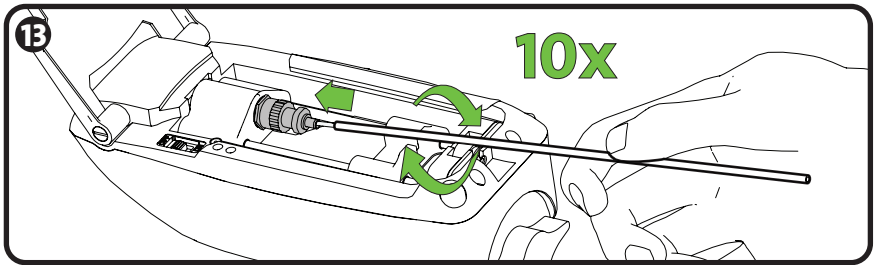
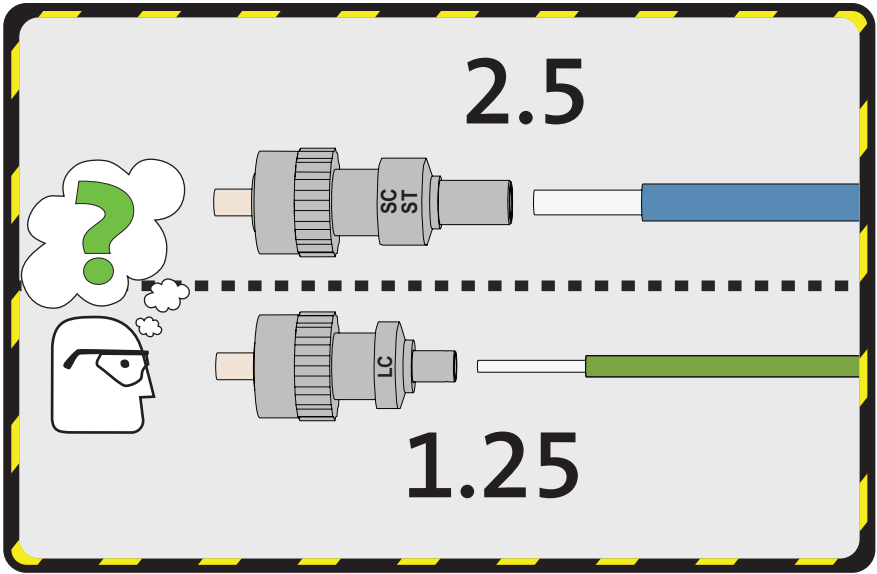

Cleaning the FBC-007 Cleaver

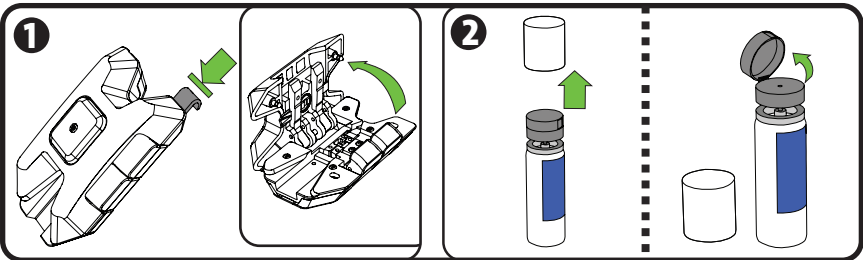
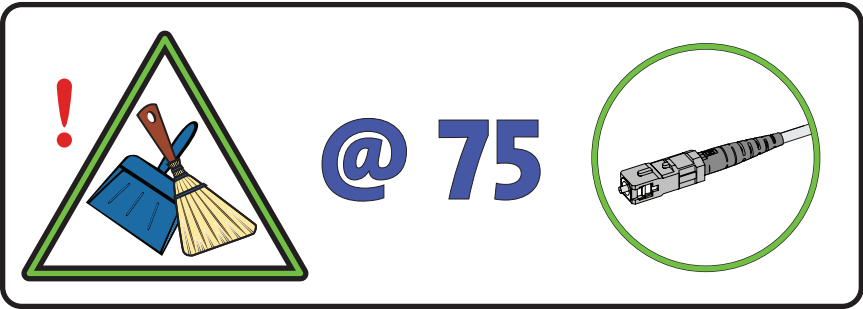
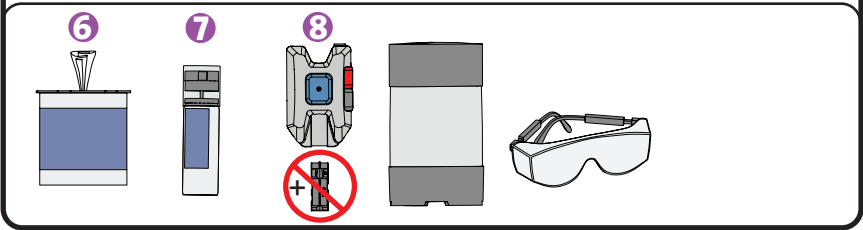
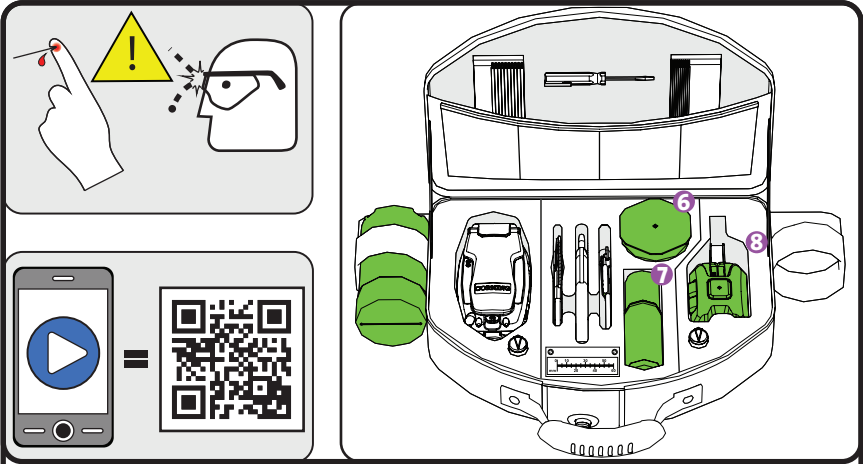

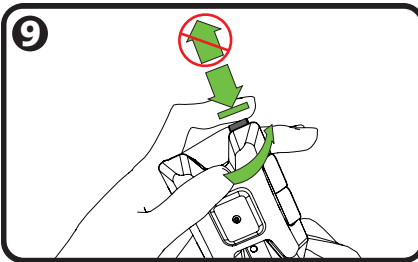
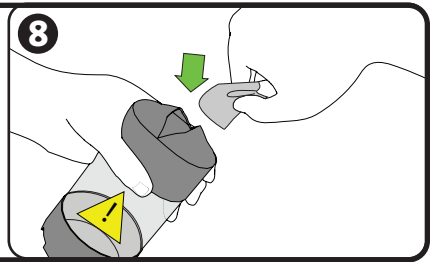
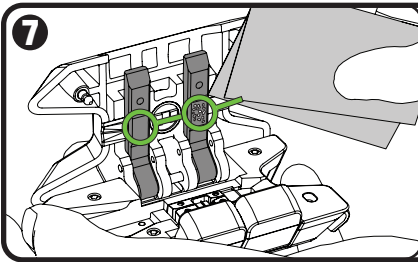
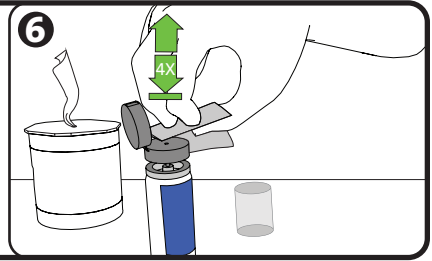
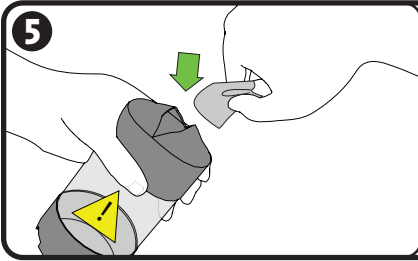
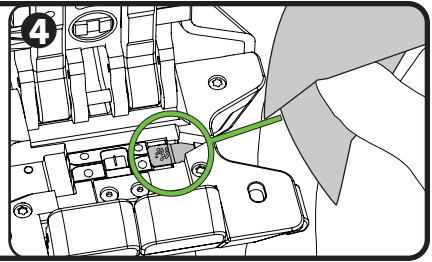
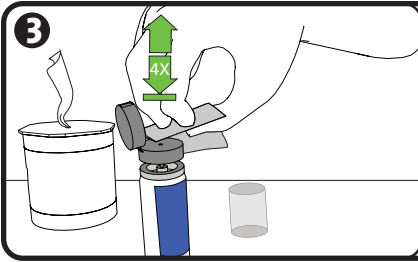

CORNING

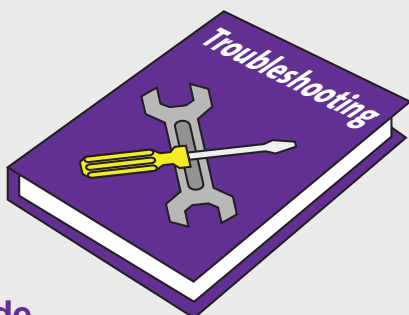

Troubleshooting Guide

To access the troubleshooting guide, please visit us at the link below or scan the QR code (above) with your smartphone:

<http://www.corning.com/opcomm/UniCamITG>

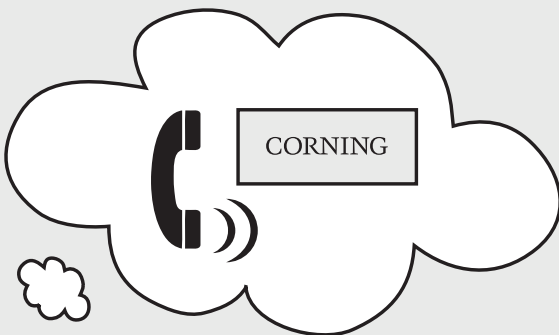

United States: 800-743-2675
 Europe, Middle-East and Africa:
 +00-800-2676-4641

Corning Optical Communications LLC • PO Box 489 • Hickory, NC 28603-0489 USA
 800-743-2675 • FAX: 828-325-5060 • International: +1-828-901-5000 • www.corning.com/opcomm

Corning Optical Communications GmbH & Co. KG • Leipziger Strasse 121 • 10117 Berlin, GERMANY
 +00 800 2676 4641 • FAX: +49 30 5303 2335 • www.corning.com/opcomm/emea

Corning Optical Communications LLC • PO Box 489 • Hickory, NC 28603-0489 USA

800-743-2675 • FAX: 828-325-5060 • International: +1-828-901-5000 • www.corning.com/opcomm

Corning Optical Communications reserves the right to improve, enhance, and modify the features and specifications of Corning Optical Communications products without prior notification. A complete listing of the trademarks of Corning Optical Communications is available at www.corning.com/opcomm/trademarks. All other trademarks are the properties of their respective owners. Corning Optical Communications is ISO 9001 certified. © 2012, 2015 Corning Optical Communications. All rights reserved. LAN-1491-AEN / October 2015

CORNING