

# Everon® Power Supply Unit (PSU) Managed Remote Power Solution

Features	Benefits	
Application	LAN switches or GPON ONTs Distributed Antenna Systems	LED Lighting Security/Access Control
Common Power Source Features	<ul style="list-style-type: none"> <li>AC input range: 110 VAC to 240 VAC/19A max</li> <li>Power factor (type): 0.97/230 VAC at full load</li> <li>Forced air cooling, built-in fans</li> <li>Two output port options: 16-port or 32-port model</li> <li>Output power and derating                             <ul style="list-style-type: none"> <li>Nominal power of up to 3,000 W shared with all output ports</li> <li>Derating with input voltage: Output power derates linearly from 3,000 W at 180–264 VAC to 1,500 W at 90 VAC</li> <li>Derating with temperature: Output power derates linearly from 3,000 W at 45°C (122°F) to 1,500 W at 65°C (167°F)</li> </ul> </li> </ul>	<ul style="list-style-type: none"> <li>HVDC input range: 280 VDC to 370 VDC/13A max</li> <li>High efficiency up to 92%</li> <li>Two output voltage options: 56 VDC or 24 VDC</li> <li>Built-in monitoring and control:                             <ul style="list-style-type: none"> <li>Main PS output voltage monitoring/DC OK</li> <li>Overtemperature, overload, and fan alarms</li> <li>Per port voltage and current monitoring</li> <li>Per port ON-OFF control</li> </ul> </li> <li>Protections: short circuit, overload, overvoltage, and overtemperature</li> <li>Outputs protection auto-recovery</li> </ul>

## Description

The Corning® Everon® Power Source Unit (PSU) provides National Electricity Code® (NEC®) Class-2 outputs that allow various output power characteristics (greater or reduced) achieved via connectivity to an external (and thus, modular) aggregator and step-down converter units.

• **Aggregators** allow feeding loads with power higher than NEC Class-2 95 W. These aggregators are available as 2- and 8-port models.

For example: providing 150 W requires connection to two ports; providing 450 W requires connection to five ports of an 8-port model; providing 300 W may be based on a single 8-port model or by paralleling the outputs of two 2-port models, etc.

*Note: the 8-port model provides up to 700 W. The 2-port model provides up to 170 W of output power.*

• **Step-Down Converters** allow voltage reduction from 56 V to 24 V, supporting up to 90 W loads.

Corning’s Everon PSU provides the following main enhancements:

- **High density of output** ports per unit
- Supports **high-voltage DC source input**
- Status LEDs and **dry contact alarm**
- **User-defined output power characteristics** via aggregators and step-down converter units
- Option for **remote management** via Ethernet or RS-485, based on Modbus protocol (with adjusted specific format on top)



Everon PSU: 32 channels, 24 V or 56 V



Everon PSU: 16 channels, 24 V or 56 V

## System Architecture

The following diagram illustrates the power characteristics and connectivity between the Corning® Everon® PSU and external units:

### 2- and 8-Port Aggregators and Step-Down Converter

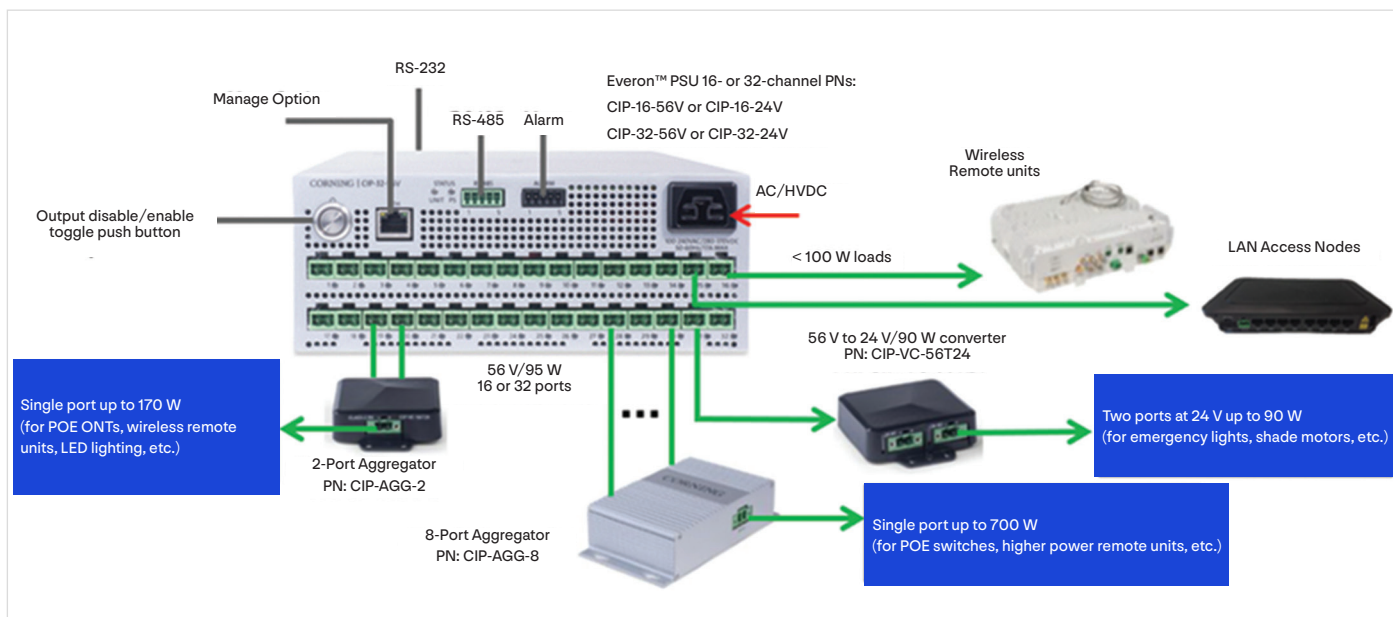

## Important safety-related notes to read prior to installation

- 1 Corning recommends that all designs using the Corning Everon® Managed Remote Power Solution comply with the latest editions of the NEC of the NFPA, OSHA, and all applicable Local and State codes
- 2 The rear panel ventilation holes must NOT be installed facing downwards
- 3 Protective ground connection to the Everon PSU should be done by a certified technician. Permanent earth connection should be at least 2.5 mm<sup>2</sup>/12 AWG
- 4 All terminal block mating connectors should not be removed – even if they are not being used
- 5 Disable all outputs and disconnect the power input cable before servicing the Everon PSU
- 6 The Everon PSU Class-2 provides a maximum 95 W output, allowing cables to be routed without conduits
- 7 The output of the aggregator is a Class-1 circuit (providing more than 95 W). The aggregator should be located near the load to avoid conduit installation.
- 8 The outputs of the aggregators should be connected only to safety-approved devices
- 9 The outputs of multiple aggregators may be wired parallel to each other to achieve higher power as needed, but all Class-2 input ports should be from the same Everon PSU
- 10 For redundant applications, only the same number of Class-2 ports from multiple Everon PSUs may be aggregated together
- 11 The aggregator and converter are provided as separate units, and to be ordered individually
- 12 The dry contact alarm can be used for common/general fault monitoring
- 13 Communication ports functionality is optional
- 14 RS-232 port is for factory use only

## Environmental Specifications

Feature	Description
Working temperature	-20°C to +65°C (-4°F to +149°F) (refer to power source derating specifications)
Working humidity	0% to 90% RH non-condensing
Storage temperature	-40°C to +70°C (-40°F to +158°F)
Storage humidity	10% to 95% RH
Vibration	10 Hz to 500 Hz, 2G 10 min/cycle, 40 min each along X, Y, Z axes

## Standards and Certifications

Feature	Description
EMC	FCC CFR 47 Part 15 Subpart B, EN 55035:2017, EN 55032:2015 CISPR 32, AS/NZS CISPR 32: 2012EN 61000-3-2: 2014, EN 61000-3-3:2013, EN 61000-4-8: 2010
Safety compliance	UL/EN/IEC 62368-1 Edition 2 as a LPS (Limited Power Source)
Regulatory Compliance	CE / UKCA

## Power Specifications

Feature	Description
Input power source	AC/HVDC
Max power consumption	16 Ports: Max 1,700 W 32 Ports: Max 3,400 W
Max input current	19A with 110 VAC, 13A with 280 VDC
Output port power	56 VDC or 24 VDC, supporting up to 95 W per port

### Notes:

- 1) For the 32-channel Corning® Everon® PSU model: in order to always get maximum power, there is a need to work 220/240 VAC or, alternatively, with HDVC 280 VDC to 370 VDC.
- 2) In both the 16- and 32-channel PSU models, the available power depends on temperature and input voltage. Higher temperature and/or lower AC input voltage may reduce available power. Refer to derating information.

## Interfaces Specifications: PSUs

16- or 32-port outputs/1.5U-2U Corning® Everon® PSU 16- or 32-channel PNs: CIP-16-56V or CIP-16-24V/CIP-32-56V or CIP-32-24V

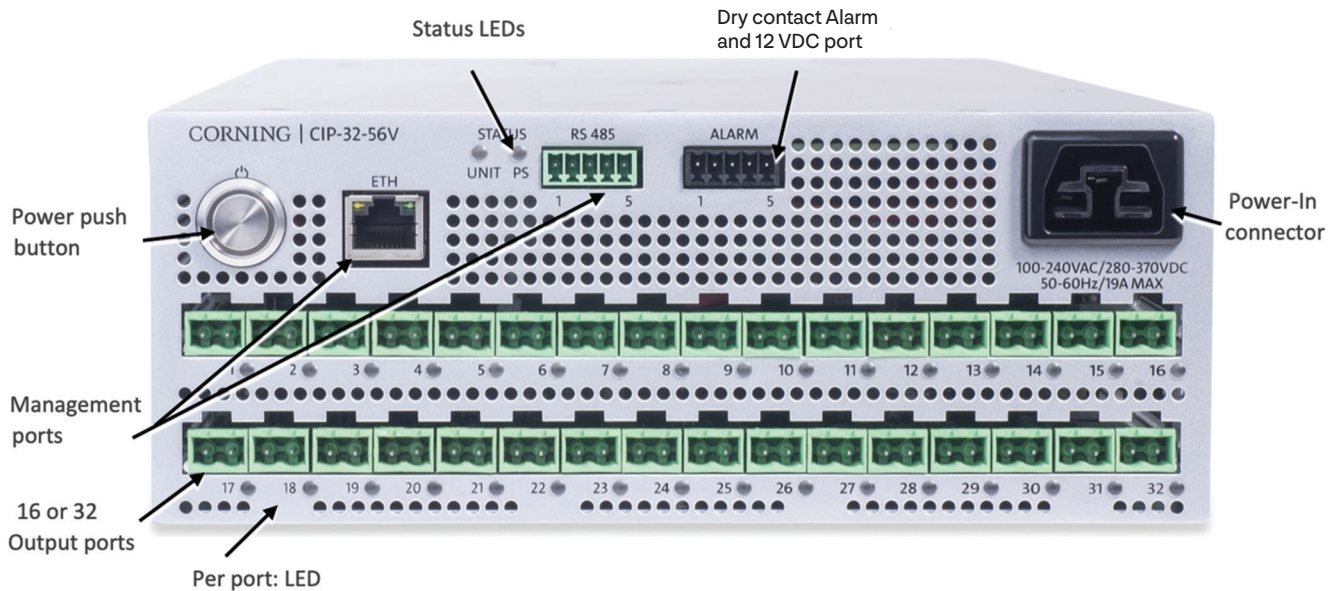

### Front Panel





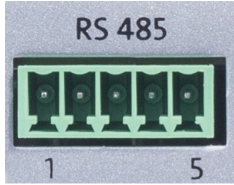
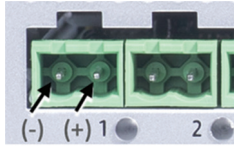

### Back Panel

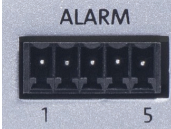

# PSU Interfaces

Feature	Description	Purpose
<p>Power push button</p> <p>In order to extend the life of the power input connector, the power input cable should be disconnected while the outputs are disabled</p>	<ul style="list-style-type: none"> <li>• <b>First long press (6 to 8 sec):</b> Disconnects all Class-2 outputs (recommended before disconnecting from power source); All ports' LEDs will turn red</li> <li>• <b>Second long press:</b> Restarts outputs (all ports LEDs will turn green if related ports are not overloaded)</li> </ul> <p>Long press toggle between all outputs enabled/disabled mode</p> <p>Switch light blinks while in disabled mode and solid while enabled</p>	 <p>Disabling or enabling all output ports</p>
<p>Management Connectors:</p> <ul style="list-style-type: none"> <li>• Ethernet</li> <li>• RS-485 bus</li> </ul>	<p><b>Optional communication functionality:</b></p> <p>Both connectors are based on Modbus protocol with a unique data formatting on top (see note below)</p> <p>The Ethernet port RJ45 – Modbus communication over 10/100 Mbps Ethernet and has two LED lights:</p> <ul style="list-style-type: none"> <li>• The green LED light (left) indicates Ethernet connection</li> <li>• The yellow LED (right) indicates that there is data transmitted over the serial port</li> </ul> <p>Terminal Block – Modbus communication over RS-485; 120 Ω termination option pins.</p> <p>RS-485 bus allows connecting a few units, where the last one need to provide 120 Ω termination.</p> <p>In case of chaining multiple units, the last PSU can provide an internal termination. The termination is activated by shorting pin 4 with pin 5 using a jumper.</p> <p>RS-485 connector pins description can be found in the Quick Installation Guide</p>	<p>Ethernet communication</p>  <p>RS-485 communication</p> 
<p>16/32 output ports</p>	<p>12 AWG to 20 AWG output interfaces</p> <p>The right pin of each output port connector is the positive signal while the left pin is the negative</p> <p>Class-2 LPS – 95 W output power per port, at maximum output voltages of 24 VDC or 56 VDC</p> <p>Support of multiple pairs paralleling with remote aggregation box for high power loads</p>	<p>Class-2 output ports (16 or 32 ports)</p> 
<p>LED (per port)</p>	<p><b>Green</b> – Power Good</p> <p><b>Red</b> – Line shorted, overloaded, or disabled</p> <p>Few seconds (up to four) after short circuit or overload condition ends, the LEDs automatically resume to green</p>	<p>Class-2 output LEDs (16 or 32 LEDs)</p> 
<p>Power-in connector (AC/HVDC)</p>	<p>Anderson Saf-D-Grid connector, supporting AC or high-voltage DC power input</p>	<p>Power Input</p>  <p>100-240VAC/280-370VDC 50-60Hz/19A MAX</p>

Feature	Description	Purpose
Dry contact alarm (for monitoring)	Dry contact for major alarm and for 12 V/3 W output: <b>Dry contact:</b> Both N.O. or N.C. alarms are available for use <b>12 V/3 W output:</b> Allows connection to accessories (i.e., optical media bridge)	Alarm Interface 
Status LEDs (unit, PS)	<b>Unit LED:</b> Green/red LED indicating unit level common alarm status. This will also be indicated by the dry contact alarm management (i.e., in the event of shortage in one of the Class-2 outputs, the LED will light red and the unit status will also light up) • Power supply faults: internal PS overvoltage, overtemperature, overcurrents • Unit faults: Short circuit or overload condition in one of the channels or internal overtemperature of the box  <b>PS LED:</b> Green/red LED indicating internal main power supply alarm status; If faulty, all outputs will be disabled (this also may happen due to overheating)	 System status indications: • Unit status • PS status
RS-232 (back panel)	D-Type 9 pins (optional)/configuration RS-232 serial communication port supporting CLI commands  For factory/Corning technician use only	RS-232 Interface 
Ground terminal (back panel)	Grounding is required to ensure safety compliance	Chassis grounding 

Note: Future/optional management enhancement: based on Modbus protocol over Ethernet or over RS-485 includes a unique data formatting, to be used with a dedicated SW tool. Please contact Corning Marketing Team if activation is needed.

## Physical Specifications

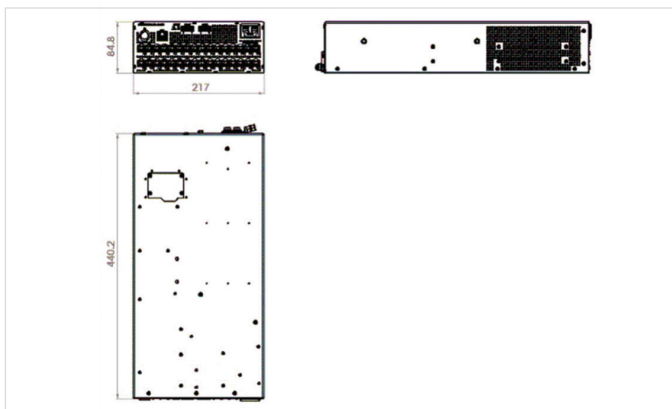

32-port model

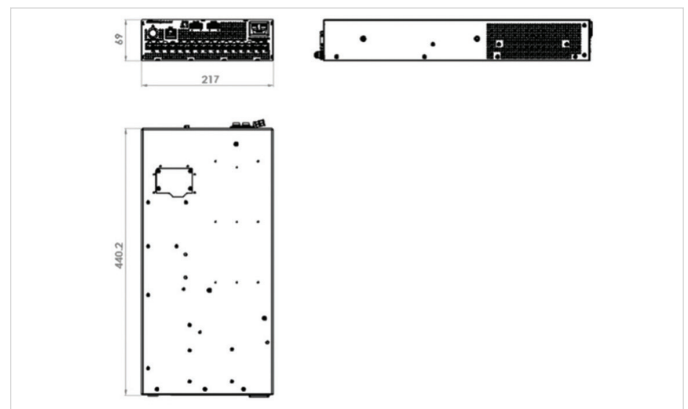

16-port model

Feature	Description
<b>32-port model (2 RU)</b>	
Dimensions (H x W x D)	85 x 217 x 440 mm (3.3 x 8.5 x 17.3 in)
Weight	6.5 kg (14 lbs)
<b>16-port model (1.5 RU)</b>	
Dimensions (H x W x D)	69 x 217 x 440 mm (2.7 x 8.5 x 17.3 in)
Weight	5.5 kg (12 lbs)

## Mount Installation

See Quick Installation Guide for details



## Ordering Information

Unit and accessories (refer to Quick Installation Guide for further installation details)

Class-2 Related Units

Part Number	Description	Image
CIP-16-56V	Corning® Everon® PSU, 16-port model with 56 VDC Class-2 outputs	
CIP-32-56V	Everon PSU, 32-port model with 56 VDC Class-2 outputs	
CIP-16-24V	Everon PSU, 16-port model with 24 VDC Class-2 outputs	
CIP-32-24V	Everon PSU, 32-port model with 24 VDC Class-2 outputs	

## Accessories Included with Everon® PSU Basic Kit

Part Number	Description	Image
264A418601 (included in basic kit)	Everon PSU Mounting Bracket Equipped with single-stacked configuration wall-mounting brackets (2 units)	Two brackets for each Everon PSU: 
705A070601 (included in basic kit)	AC cable for Everon PSU 12 AWG, 25A/370 V Connector on one side with open wires on the other side to allow adjustment to 110 or 240 VAC input	Single-ended plug assembly 

## Accessories Kit (optional, to be ordered separately)

Part Number	Description	Image
CIP-AGG-2 2-Port Aggregator	Two Class-2 inputs per aggregator (supports 24 VDC to 56 VDC Class-2 inputs x 2) Cable-side Dinkle connectors are attached to the unit	
CIP-AGG-8 8-Port Aggregator	Eight Class-2 inputs per aggregator (supports 24 VDC to 56 VDC Class-2 inputs x 8) Cable-side Dinkle connectors are attached to the unit	
CIP-VC-56T24 Step-Down Converter	Class-2 56 VDC to 24 VDC step-down converter (up to 90 W input distributed over two 24 V outputs) Multiple CIP-VC-56T24 converter outputs that are powered from 56 VDC Corning® Everon™ PSU ports may be aggregated with the 2- or 8-port aggregator to feed big loads	
CIP-CBLMGMT	0.5RU Cable Management Kit For 16-port units, the cable management fills the missing 0.5U shelf to complete 2U	
CIP-19SHELF-1.5U	19-in rack-mount shelf with 1.5U and 2U blank plates for CIP-16-56V and CIP-16-24V The 1.5U and 2U blank plates have two different orientations to fit both 1.5U and 2U Everon PSUs	 <p>U shelf</p> <p>1.5U and 2U blank plates Orientation-2 to fit 2U shelf</p>
CIP-19SHELF-2U	19-in rack-mount shelf with 1.5U and 2U blank plates for CIP-32-56V and CIP-32-24V The 1.5U and 2U blank plates have two different orientations to fit both 1.5U and 2U Everon PSUs	 <p>2U shelf</p> <p>1.5U and 2U blank plates Orientation-2 to fit 2U shelf</p>
CIP-DUALBKT	Wall-mountable bracket for dual-stacked configuration for all types of Everon PSUs	 <p>Two brackets are needed to support one or two Everon PSUs/wall-mount installation</p>

# CORNING

Corning Optical Communications GmbH & Co. KG • Leipziger Strasse 121 • 10117 Berlin, GERMANY  
+00 800 2676 4641 • FAX: +49 30 5303 2335 • [www.corning.com/opcomm/emea](http://www.corning.com/opcomm/emea)

Corning Optical Communications behält sich das Recht vor, ohne vorherige Ankündigung, Eigenschaften und Spezifikationen von Corning Optical Communications' Produkten zu verbessern, zu erweitern und zu modifizieren. Eine komplette Liste aller Marken von Corning finden Sie unter [www.corning.com/opcomm/trademarks](http://www.corning.com/opcomm/trademarks). Alle anderen Marken sind Eigentum ihrer jeweiligen Inhaber. Corning Optical Communications ist ISO 9001-zertifiziert. © 2024 Corning Optical Communications. Alle Rechte vorbehalten. LAN-2901-A4-BEN / Juni 2024